

EECE 1010: Electrical and Magnetic Circuits.

Problem set # 5 (Due on 23 Mar. 2013)

HKD: Hayt, Kemmerly, and Durbin

Engineering circuit analysis, 7th Edition

Tata McGraw Hill 2010, 2006

(1) Evaluate and sketch $v_o(t)$, and when marked, $i_o(t)$ in the following:

* $v_i(t)$ is a step of V_p applied at $t=0$

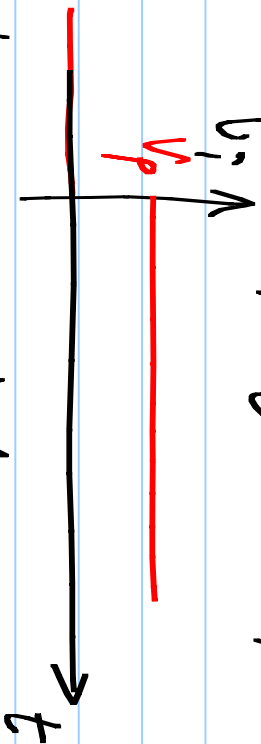

* Capacitors and inductors have zero initial condition

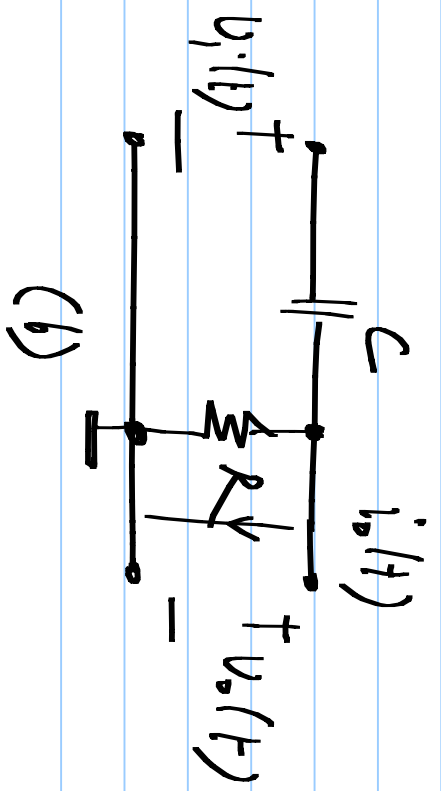
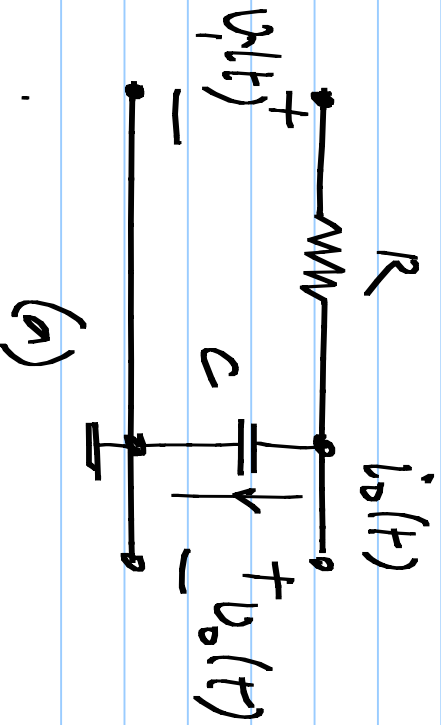

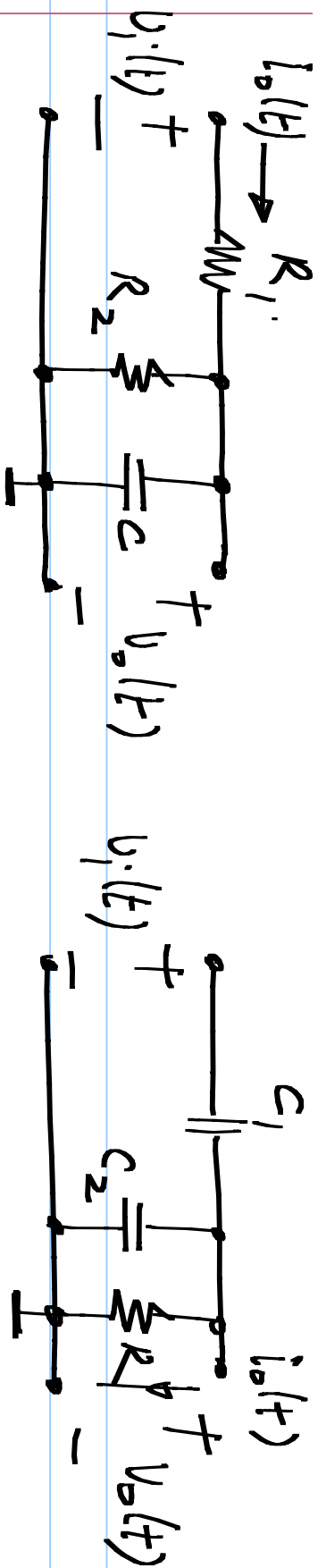

(c)

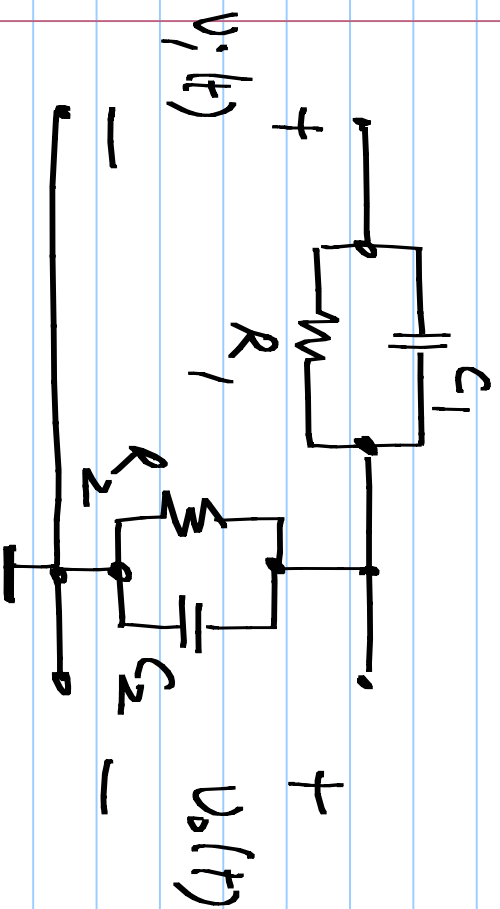

(e)

(d)

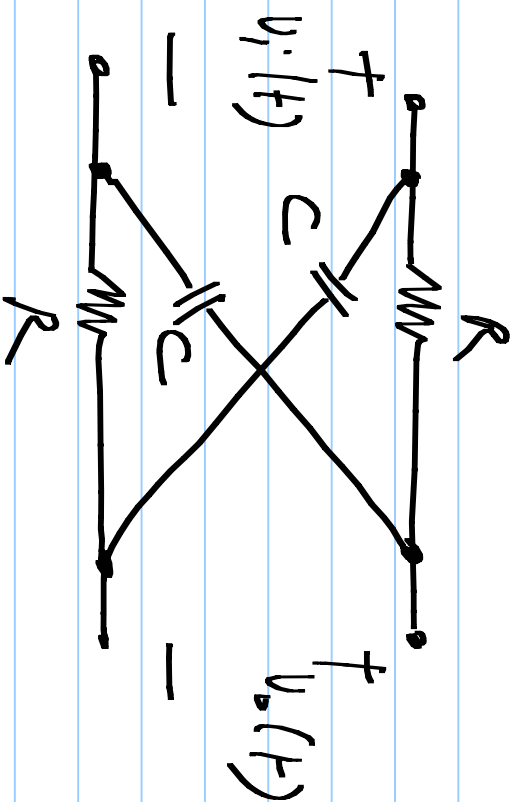

(f)

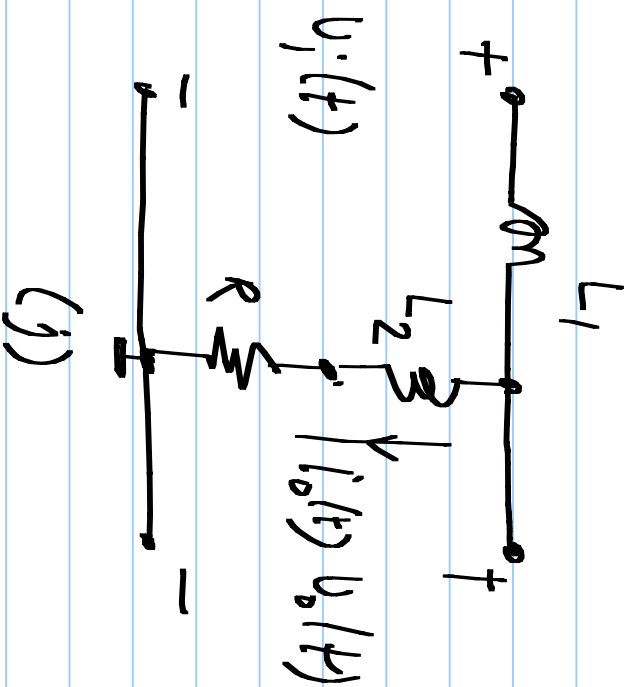
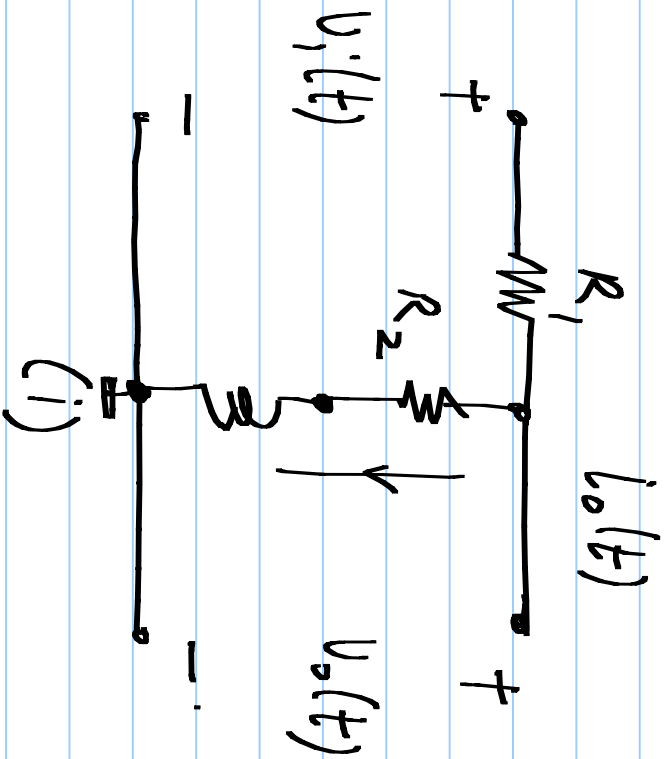
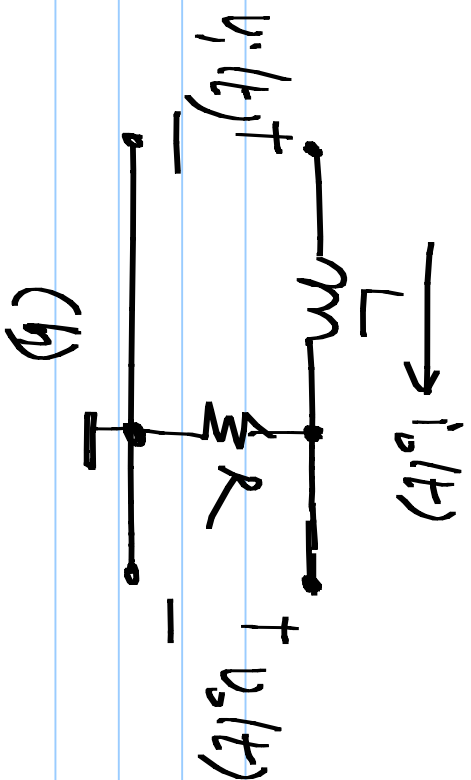
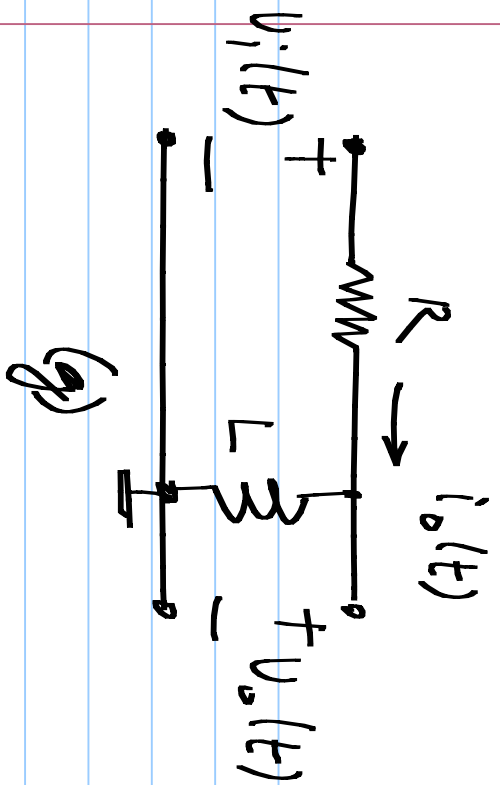

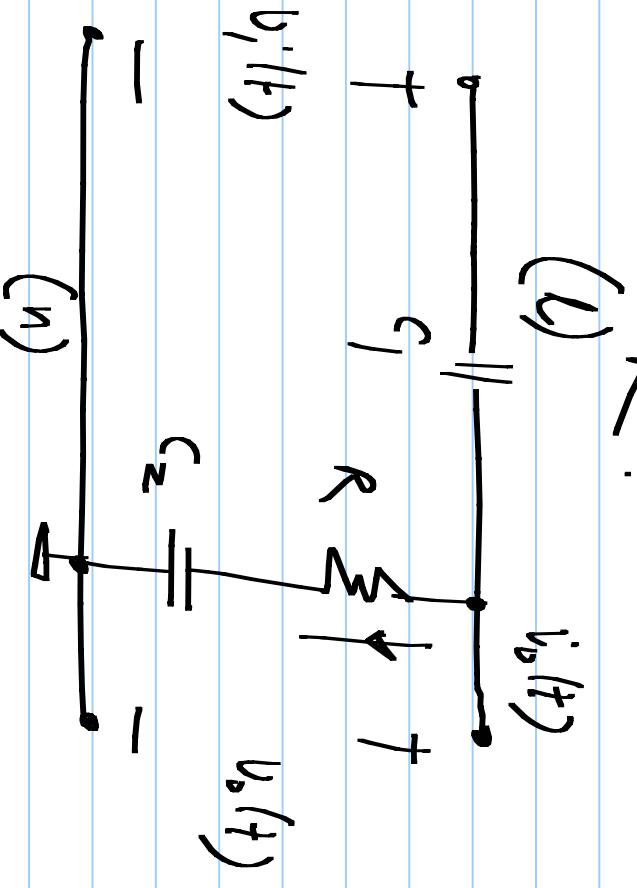
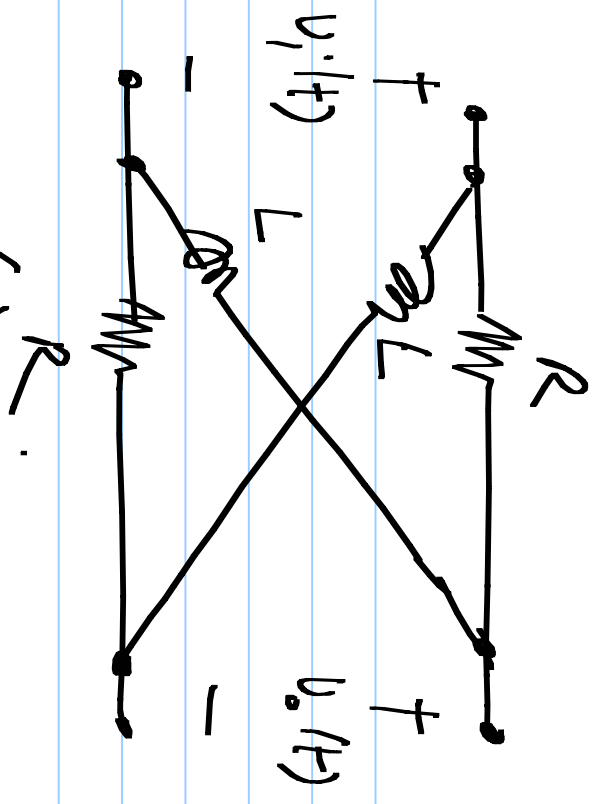
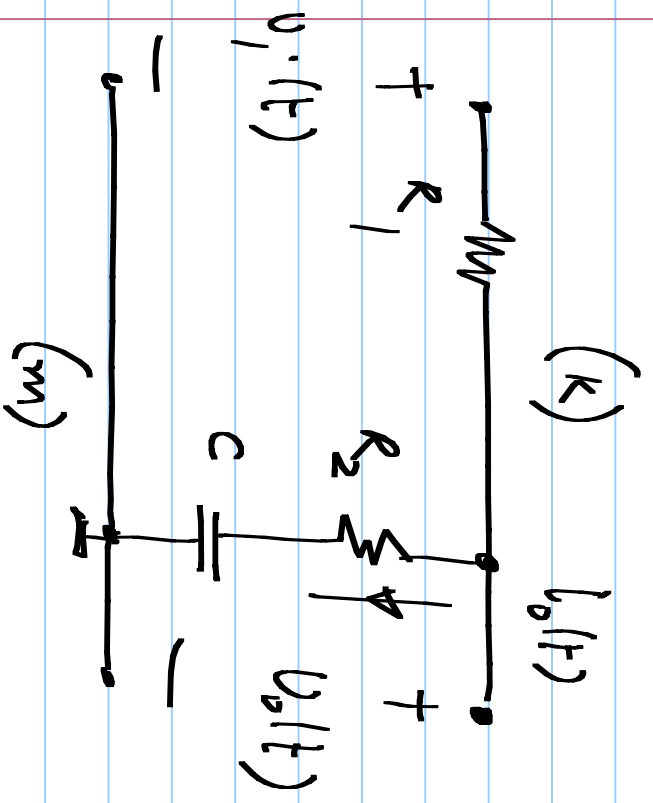
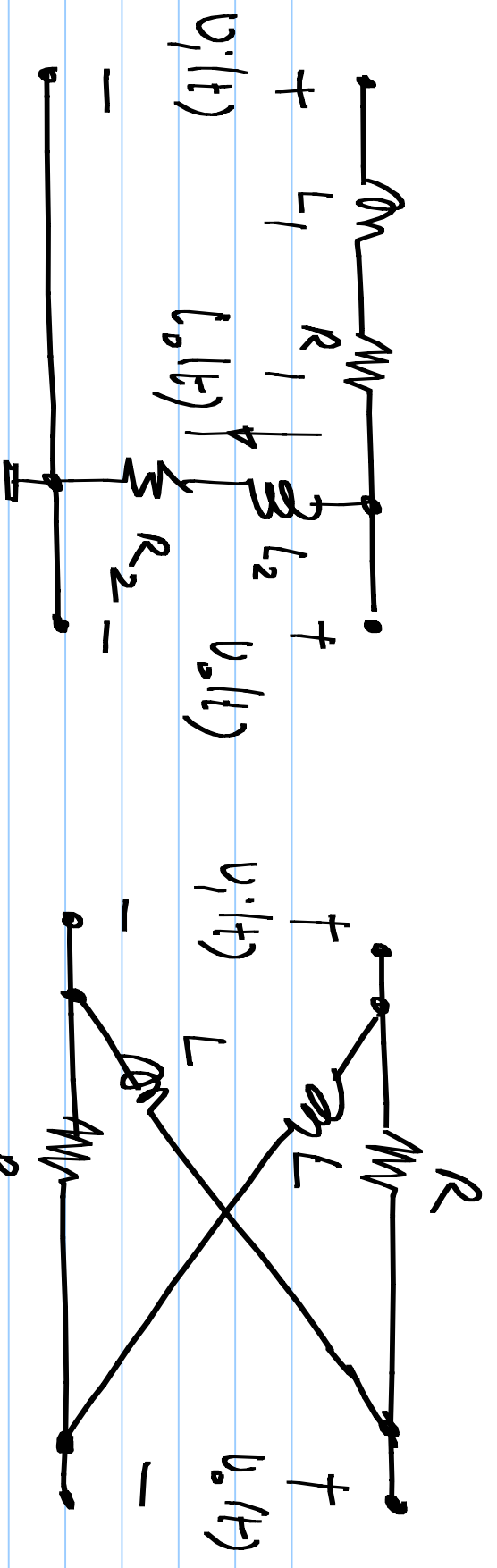

(2) Just so that you get used to a current input, calculate $v_o(t)$ when $i_i(t)$ is a step current of value I_p

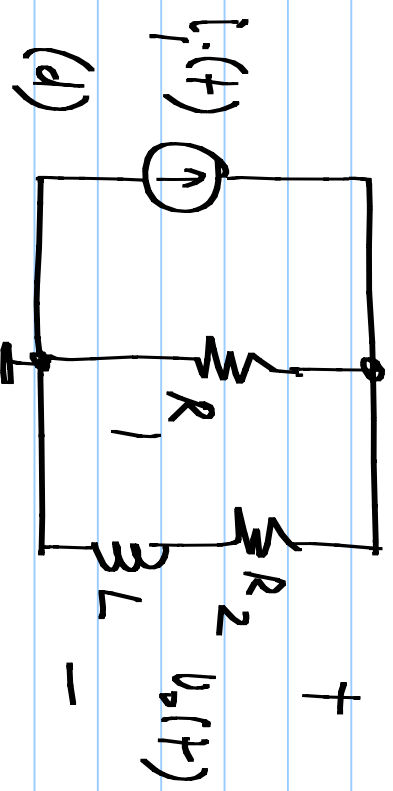
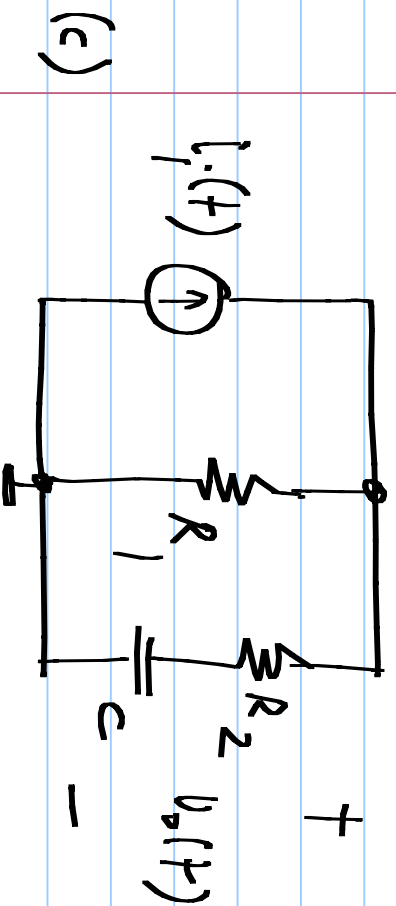
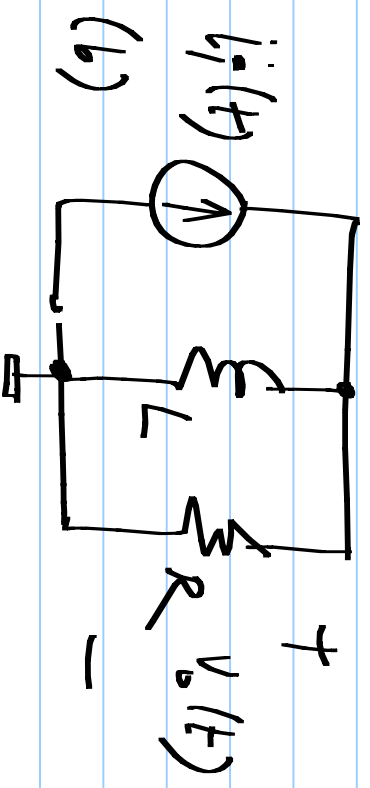
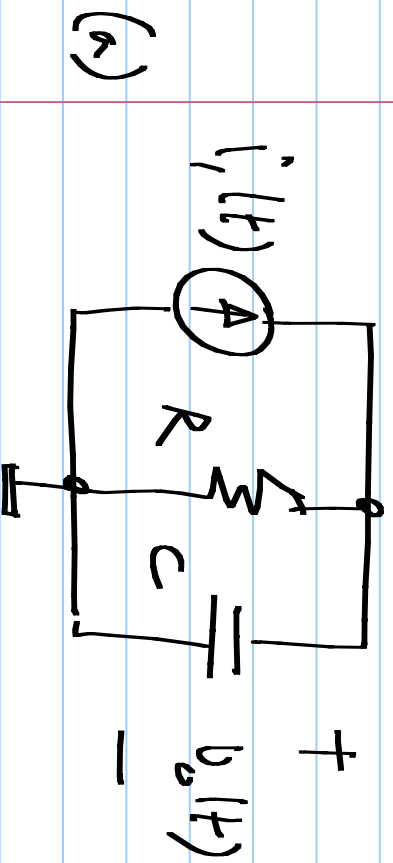

(3). In all of the previous problems, open circuit calculate v_o and i_o for an input of v_p or i_p as applicable. How are the values so obtained related to $v_o(t)$ and $i_o(t)$ you calculated earlier.

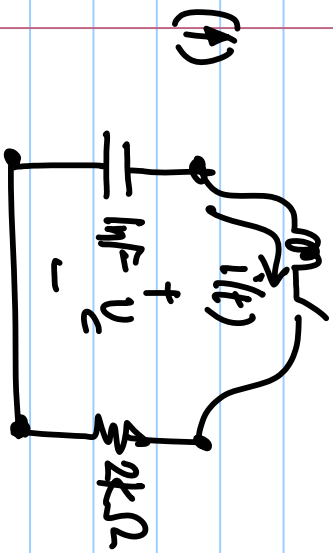

(a) A $1\mu\text{F}$ capacitor charged to 1V must be connected to a resistor through a switch to discharge it. The switch is connected using a long wire which has some inductance. Write the expressions for $V_c(t)$ & $i(t)$

when the inductance is zero, 0.1mH , $1\mu\text{H}$, and 10mH .

What are the damping (or quality) factors in each case.

(b) What are $\int_0^{\infty} i(t) dt$ and $\int_0^{\infty} i^2(t) dt$ in the three cases?

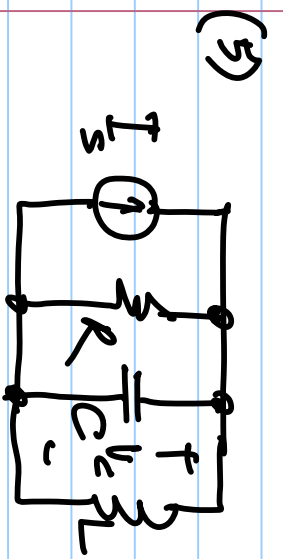

(1) Write down the differential equation governing this circuit with v_c as the variable.

(ii) Determine the conditions for under damping, critical damping, and over damping. How do these compare to the series RLC case?

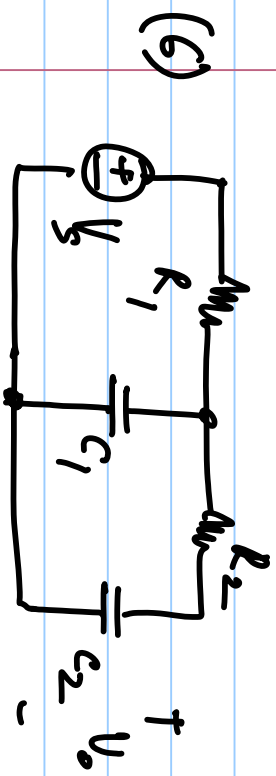

(i) Write down the differential equation with v_o as the variable.

(ii) Determine the natural frequency, damping factor, and the natural response of v_o when $R_2 = R_1 = 1k\Omega$, $C_2 = C_1 = 1\mu F$. Assume $v_{C_1}(0)$ and $v_{C_2}(0)$ as the initial conditions on the two capacitors.

(iii) What is the lowest damping factor (highest quality factor) that is possible for this circuit? What are the conditions for this to happen?

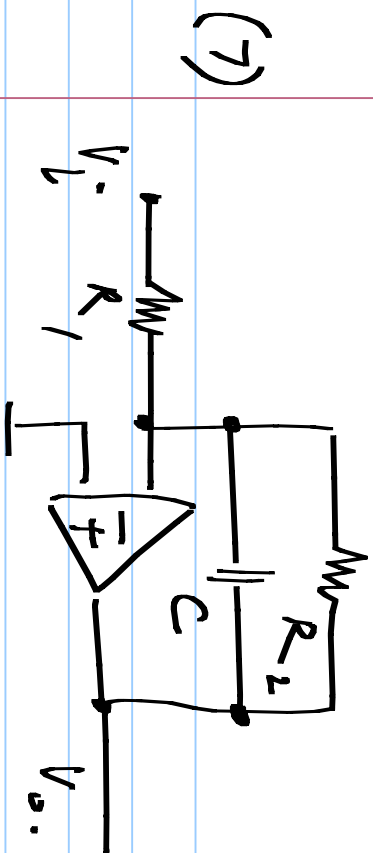

(i) Write down the differential equation for V_o

(ii) For a 1V input step, evaluate the total response