

Time Domain OCT

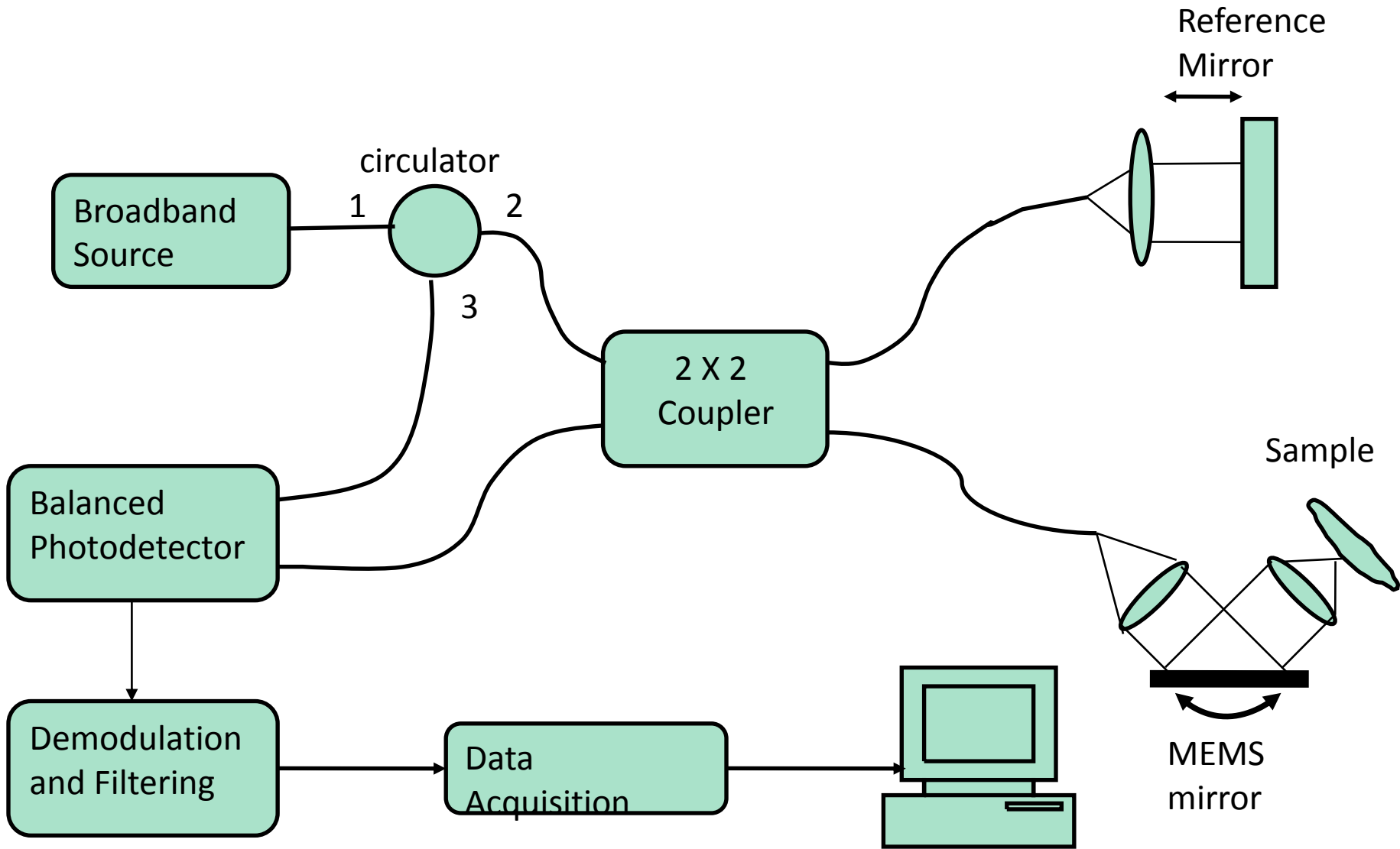

Two dimensional scan of scotch tape

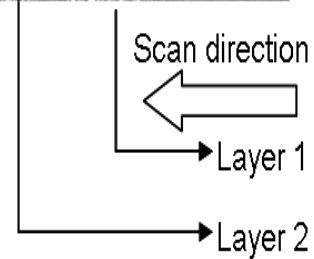
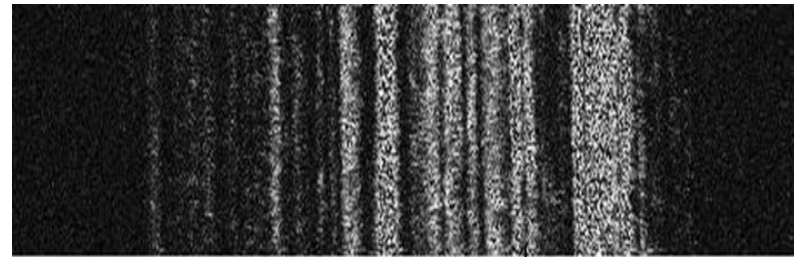

Layers : 10
Tape Base : 36 microns
Adhesive : 22 microns
Scans : 100

Scan of 4 glass slabs

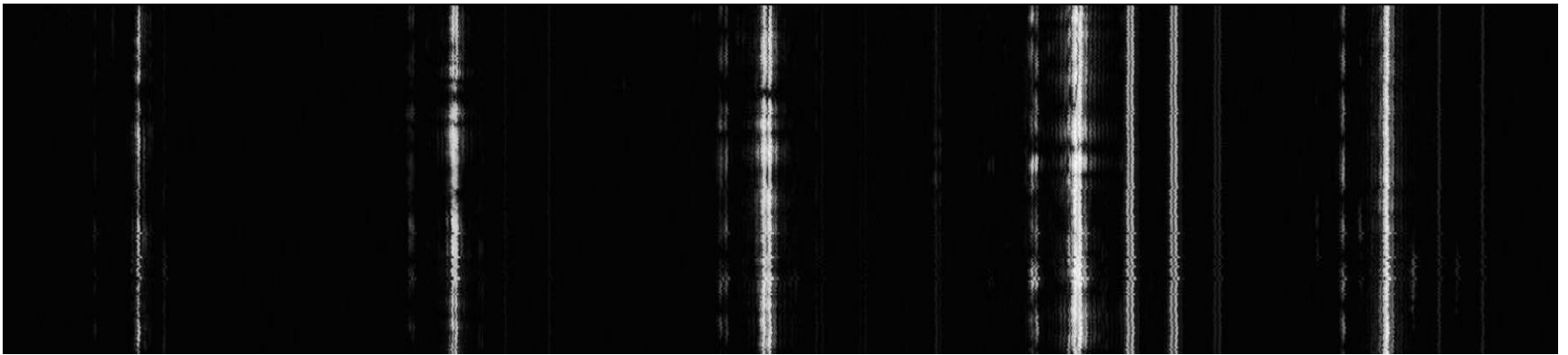

Scan Depth: 8 mm in air
Scan Range: 0.8 mm

Frequency Domain OCT

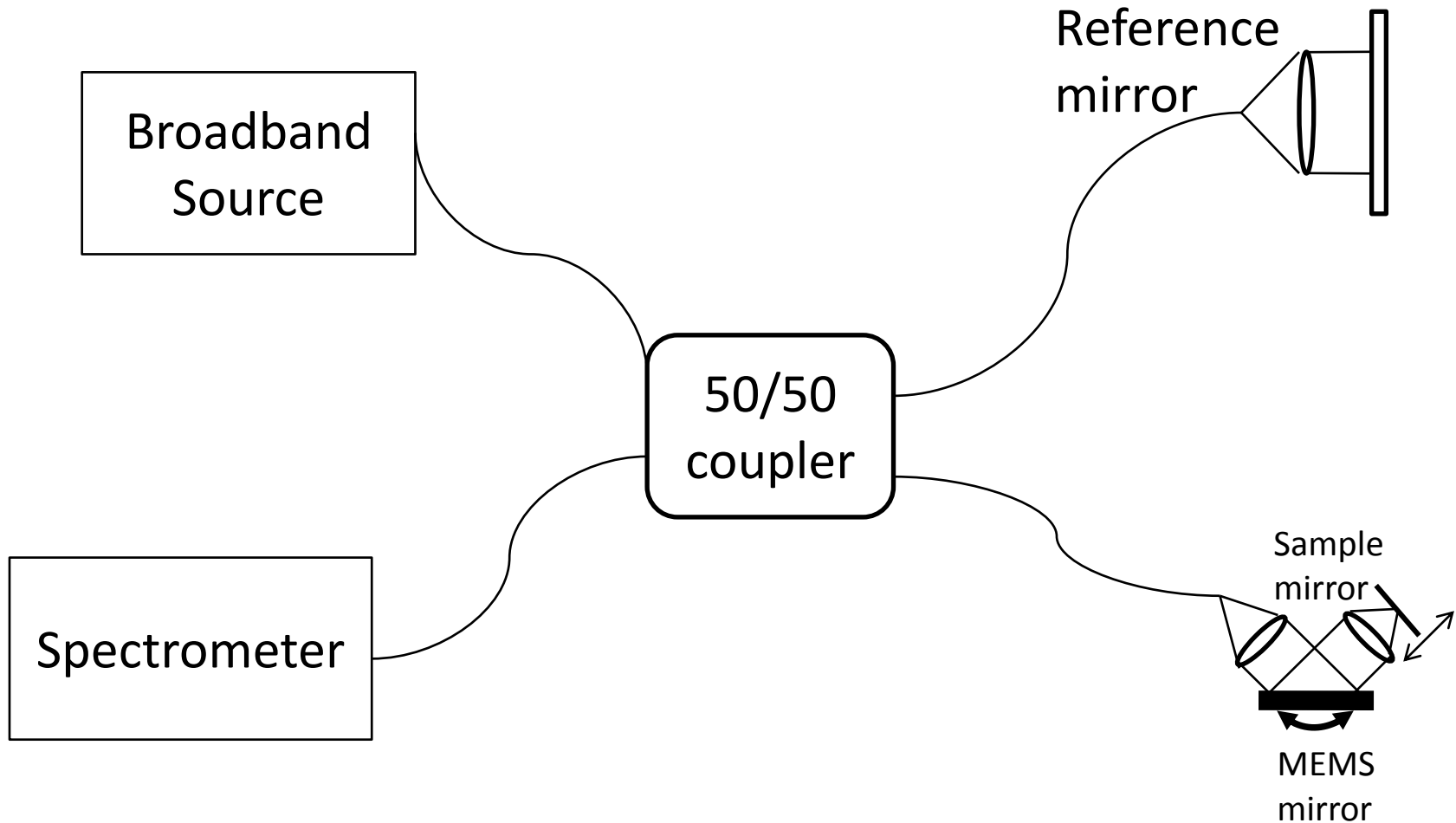

Adhesive Tape

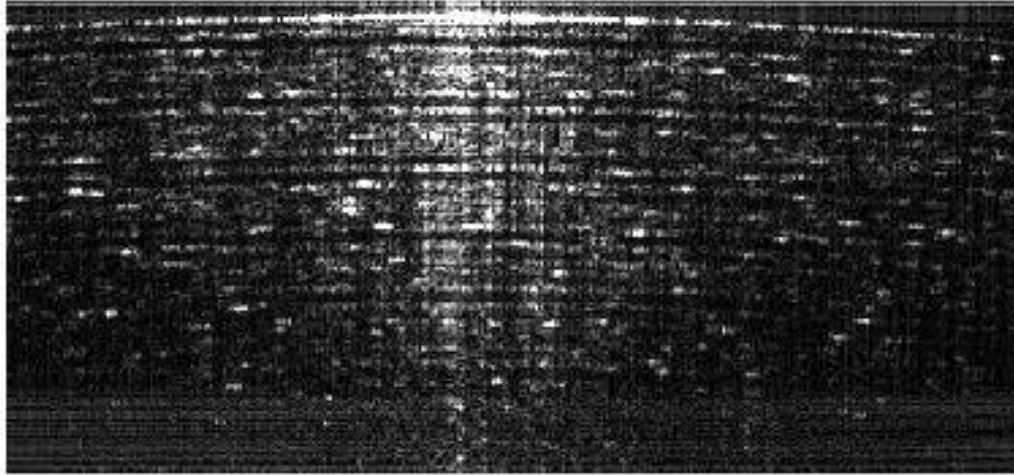

Scan Depth: 2.3mm in air
Scan Range: 2.5mm

Cucumber

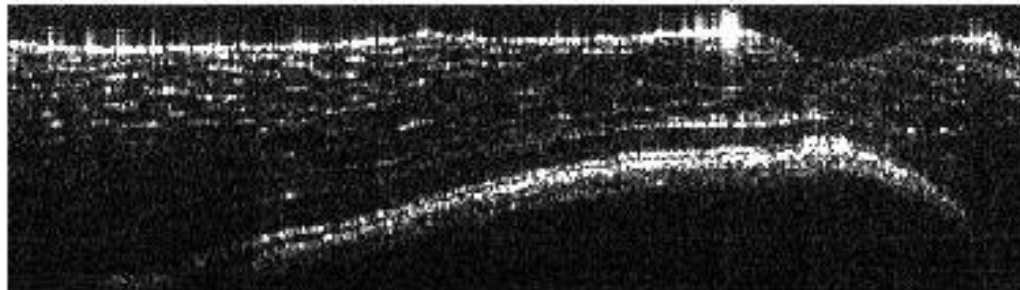

Scan Depth: 1.4 mm in air
Scan Range: 8 mm

Sine Wave

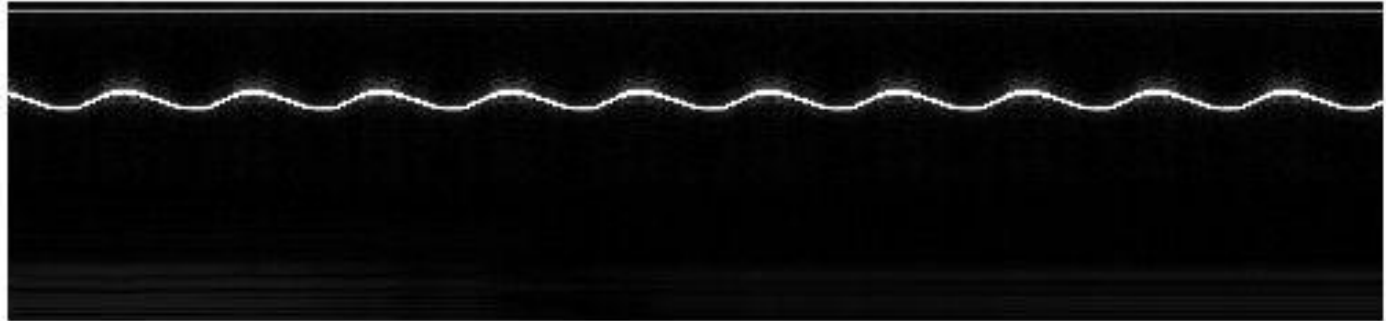

Frequency : 2Hz

Scan Rate : 220 scans per second

Triangular wave

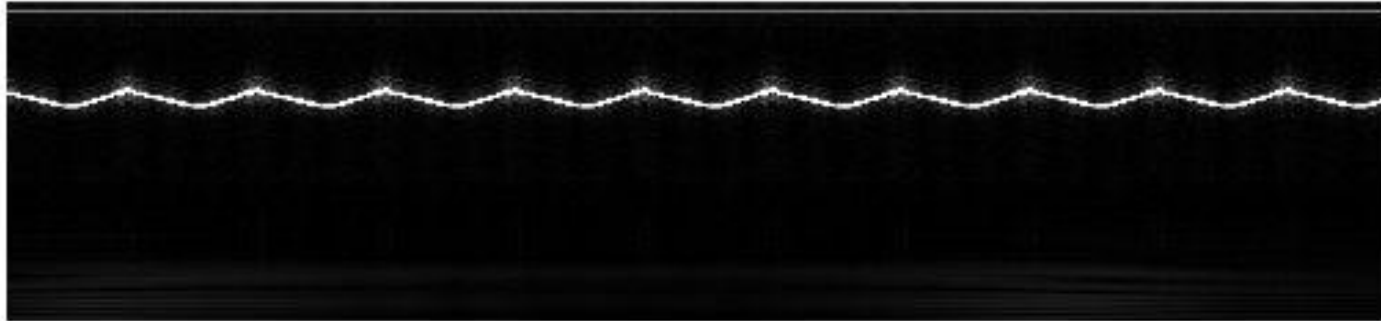

Frequency : 2Hz

Scan Rate : 220 scans per second