

Introduction to Electrical Engineering - Howework 5

1. Are the following signals periodic? If so, find the period.

a. $2 + 5 \sin 4t + 4 \sin 7t$

b. $2 \cos \sqrt{2}t + 4 \cos 3t$

2. A periodic signal is expressed by the following Fourier series:

$$x(t) = 3 + 2 \cos 2t + 5 \sin 2t + \sin 3t - \frac{1}{4} \cos(5t + \frac{\pi}{6})$$

Find the complex exponential series and sketch the magnitude and phase spectra.

3. For each of the following periodic signals, find the Fourier series representation and plot the magnitude and phase spectra.

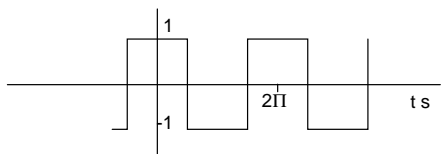
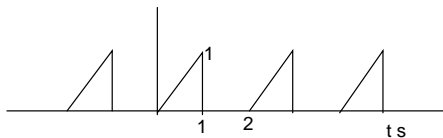

4. In the circuit shown below, the diode has a reverse saturation current $I_o = 0.1 \mu A$. Assume $V_T = 25 mV$. The non ideality factor is 1. Use trial and error and find the current in the circuit.

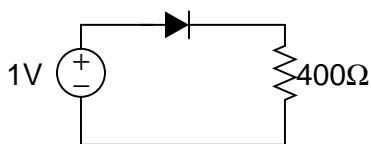

5. In the following circuit, $V_s(t) = 100 \sin 10t$. Assuming that the diode is ideal,

a. Sketch the current as a function of time

b. Find the average and rms value of the current.

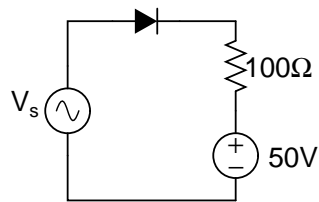

6. The input voltage $v(t) = 5 \sin 2t$. Sketch v_{out} as a function of time. The diodes are ideal.

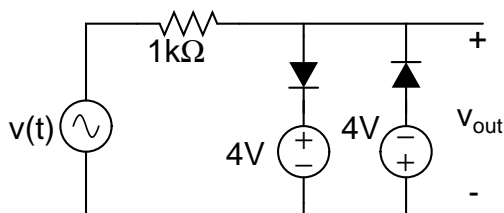

7. The input voltage $V_s(t) = \sin t$. Assuming that the diodes are ideal

a. Draw the waveform of the voltage developed across R_L .

b. Find the complex exponential Fourier series expansion of V_L .

c. If V_L is approximated by the first $2N + 1$ terms ($-N$ to N) of its Fourier series, determine N so that the power of the approximated signal is 99% of the power of $V_L(t)$.

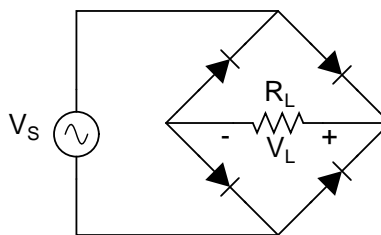

8. For the circuit shown below
- Find the complex Fourier series expansion of $f(t)$ assuming that the time period of the waveform is 2π ms.
 - Find V_{out} .

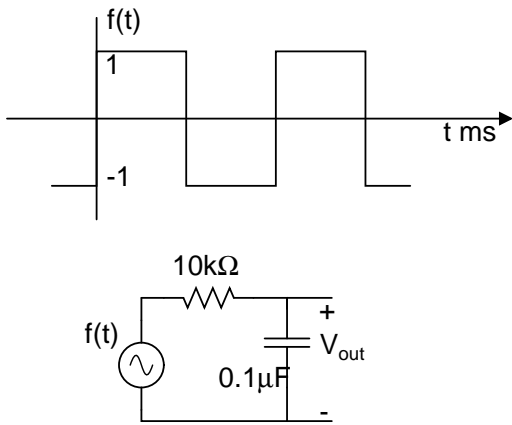

9. An AM signal is given by $[A + m(t)] \cos 2\pi 10^4 t$, where $m(t)$ is the periodic triangular waveform shown in the figure below. Sketch the waveform from 0 to 1ms for (a) $A = 20$ and (b) $A = 5$.

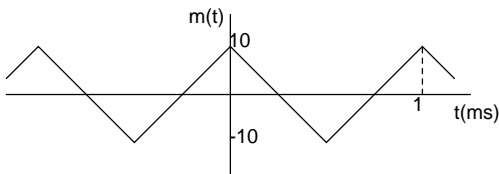

Can an envelope detector be used to detect the received signal in the two cases?

10. Sketch the magnitude spectrum of $y(t) = [1 + m(t)] \cos 10^5 t$ if
- $m(t) = 0.5 \cos 1000t$
 - $m(t) = 0.6 \cos 1000t \cos 3000t$

What is the percentage modulation in each case?

11. In the network shown below, find the expression for voltage gain and input resistance for the following two cases.
- A finite value of β .
 - In the limit as β tends to ∞ .

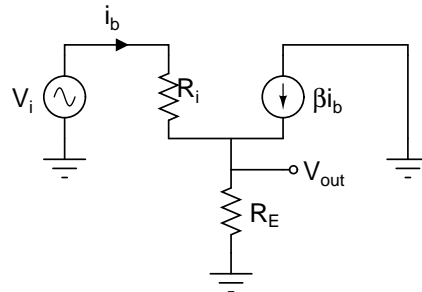

12. Find $\frac{v_{out}}{v_s}$ in the limit as R_i tends to infinity.

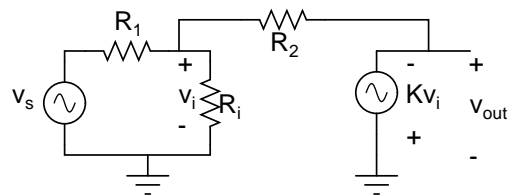

13. In the circuit shown, find I_C , V_{CE} and the voltage gain. Assume $V_{BE} = 0.7\text{V}$ and an infinite β .

