

# Strongarm latch

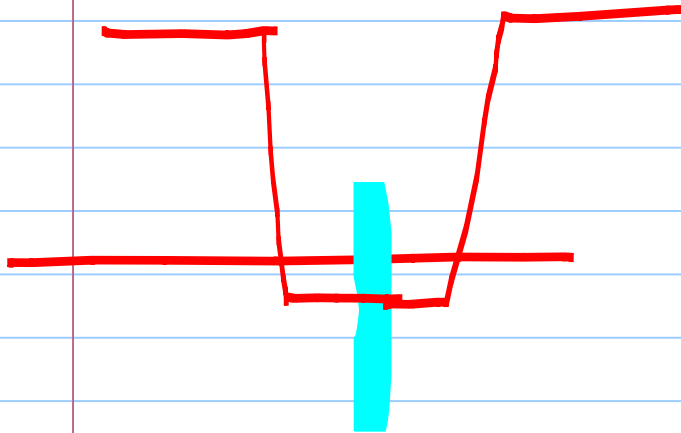

ck

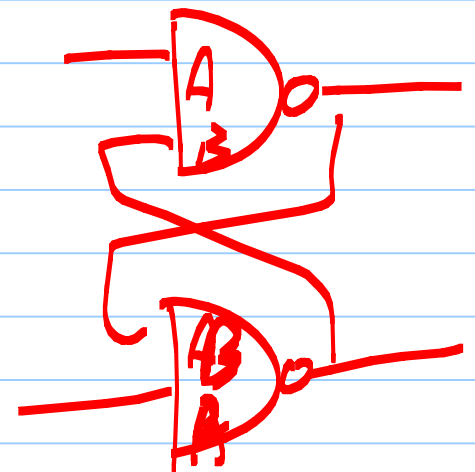

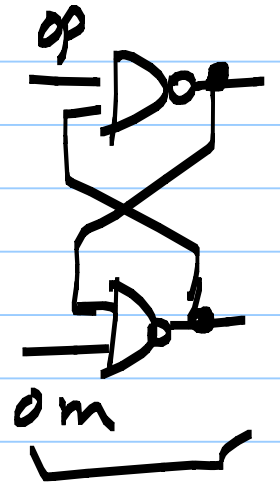
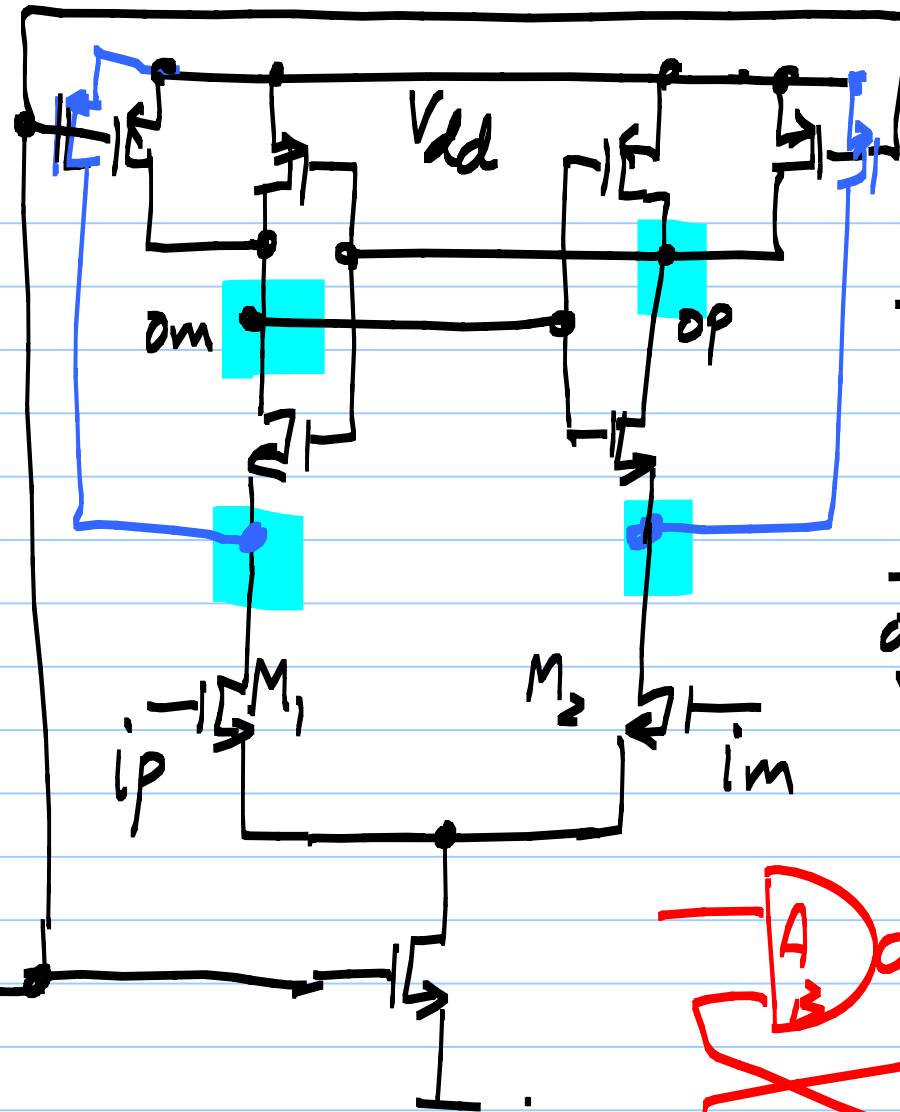
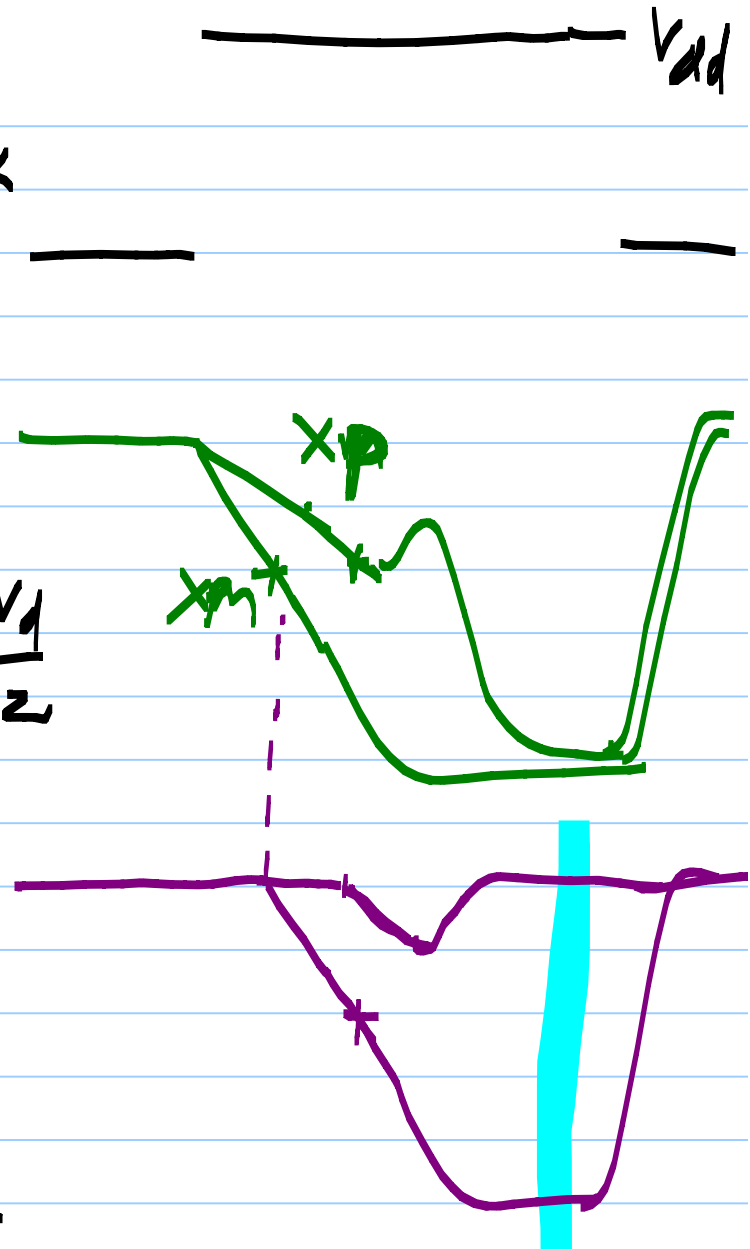
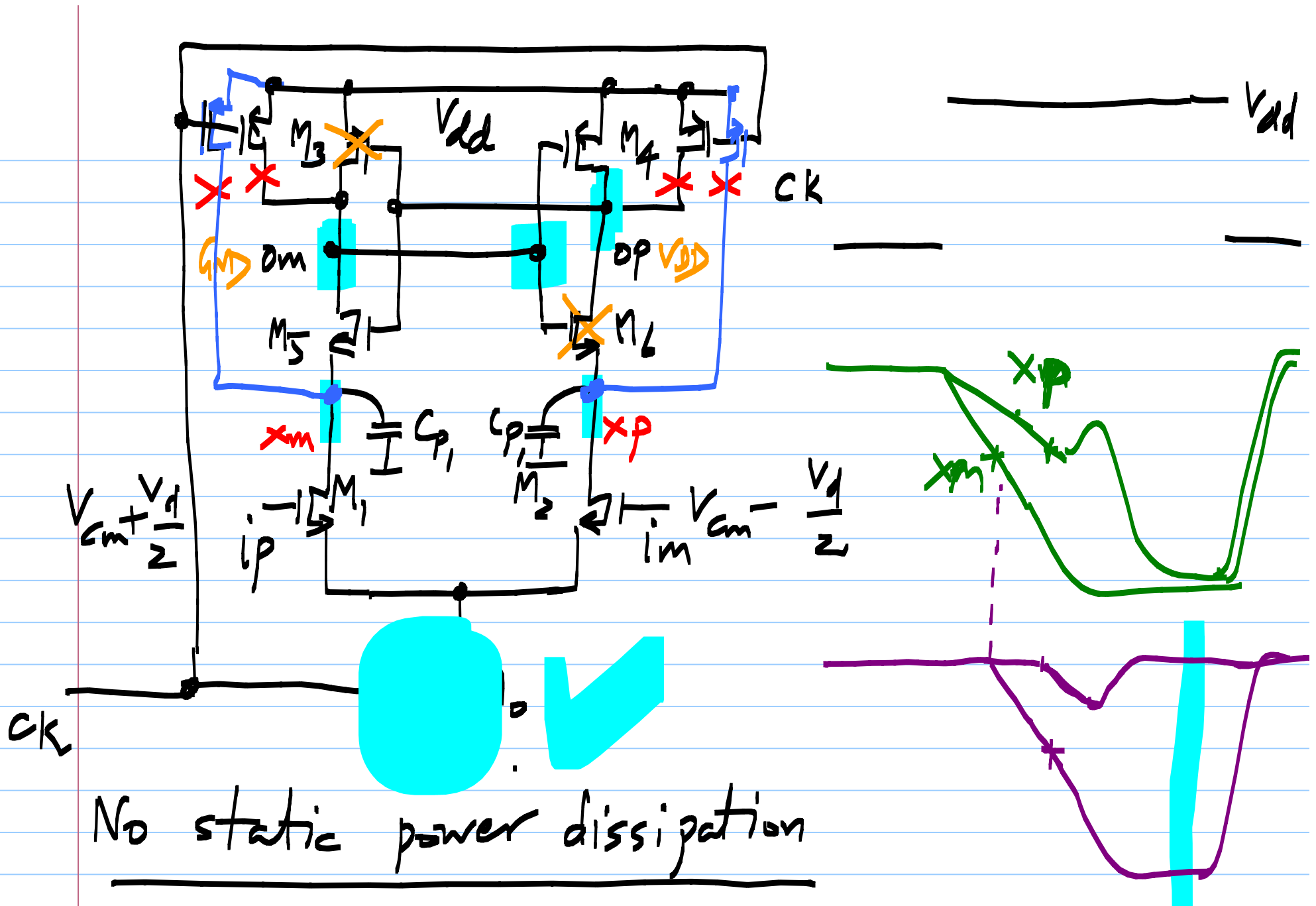

$V_i > 0$

CK

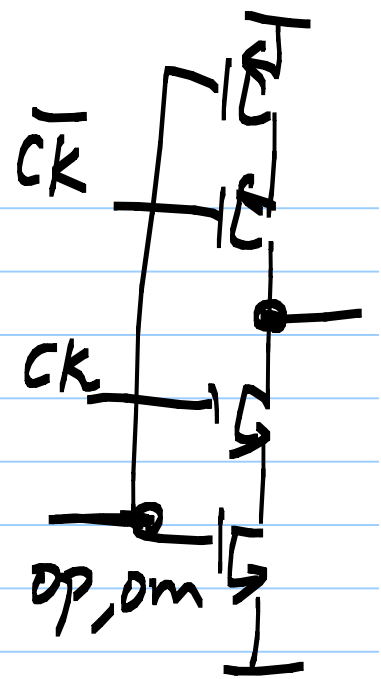
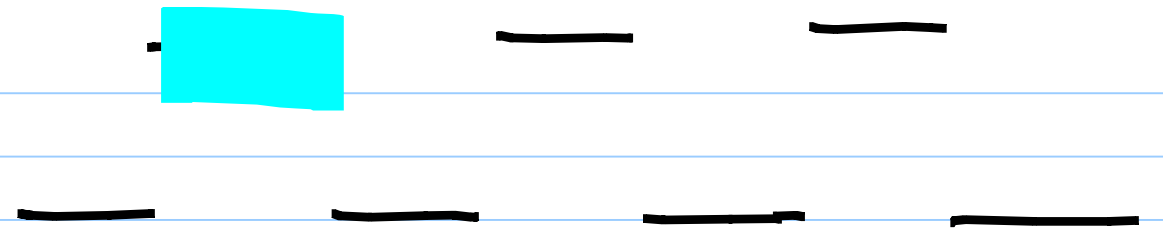

op,om

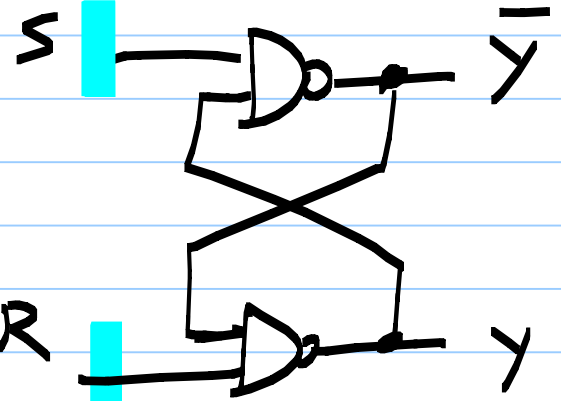
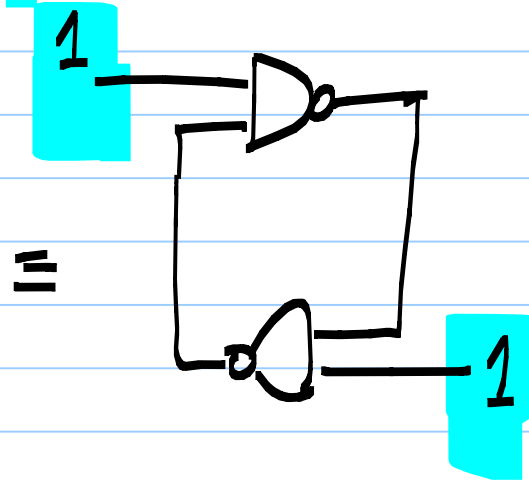
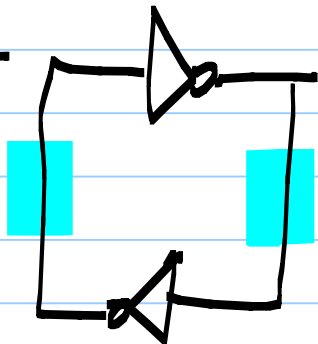
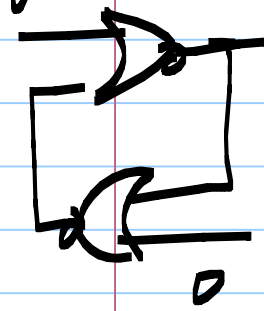

set/reset latch

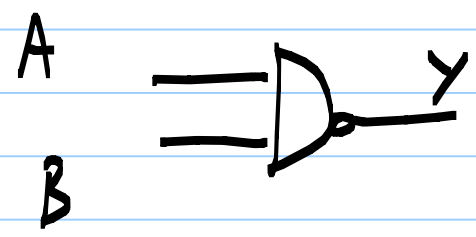
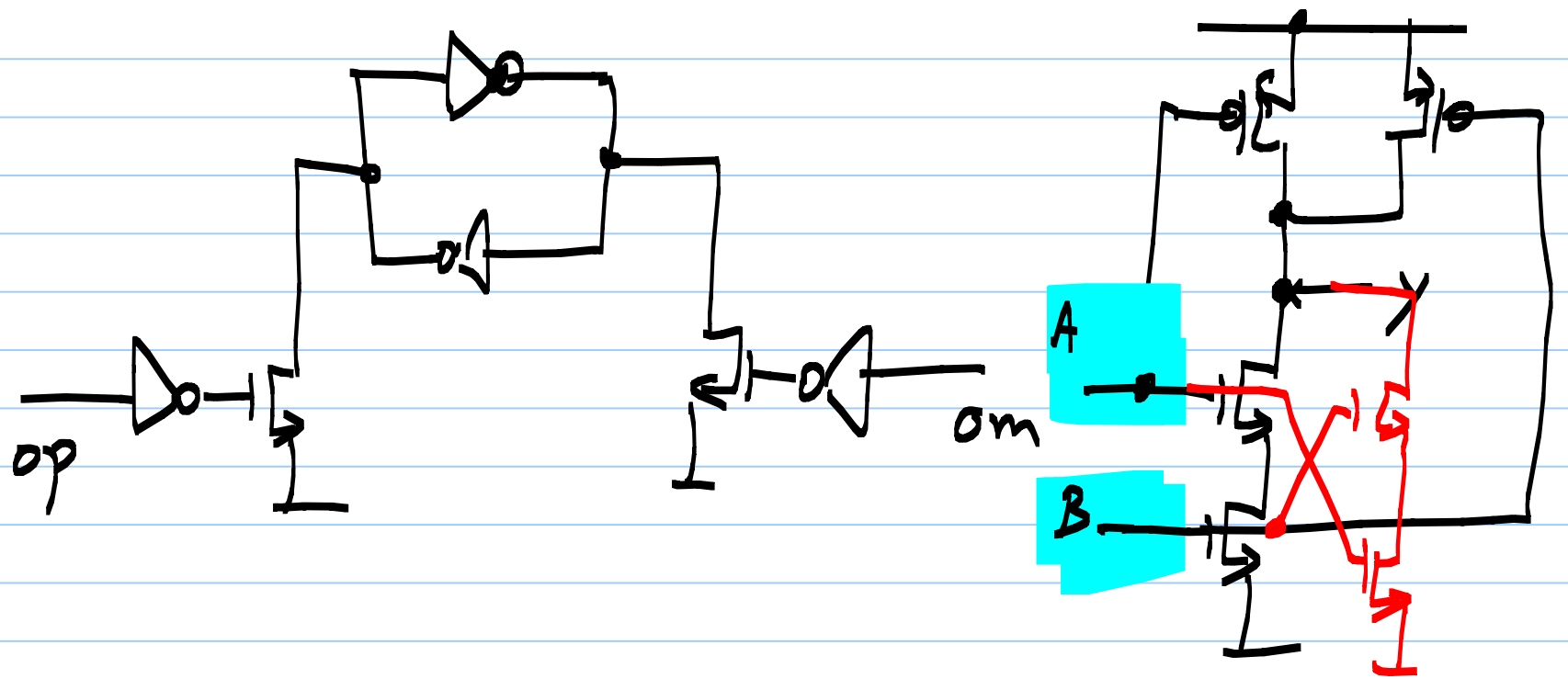

CK

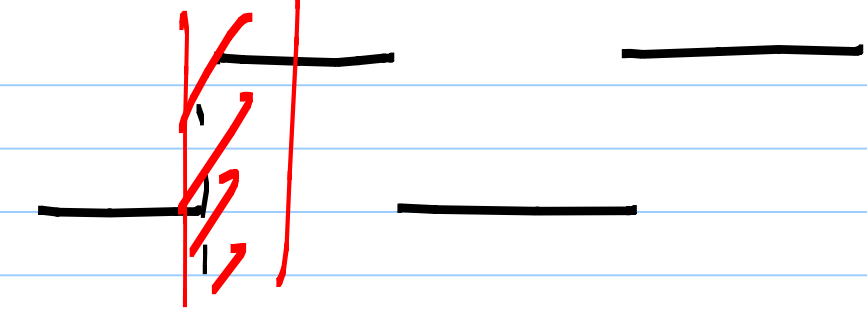

DSTA

