

ETE 2019

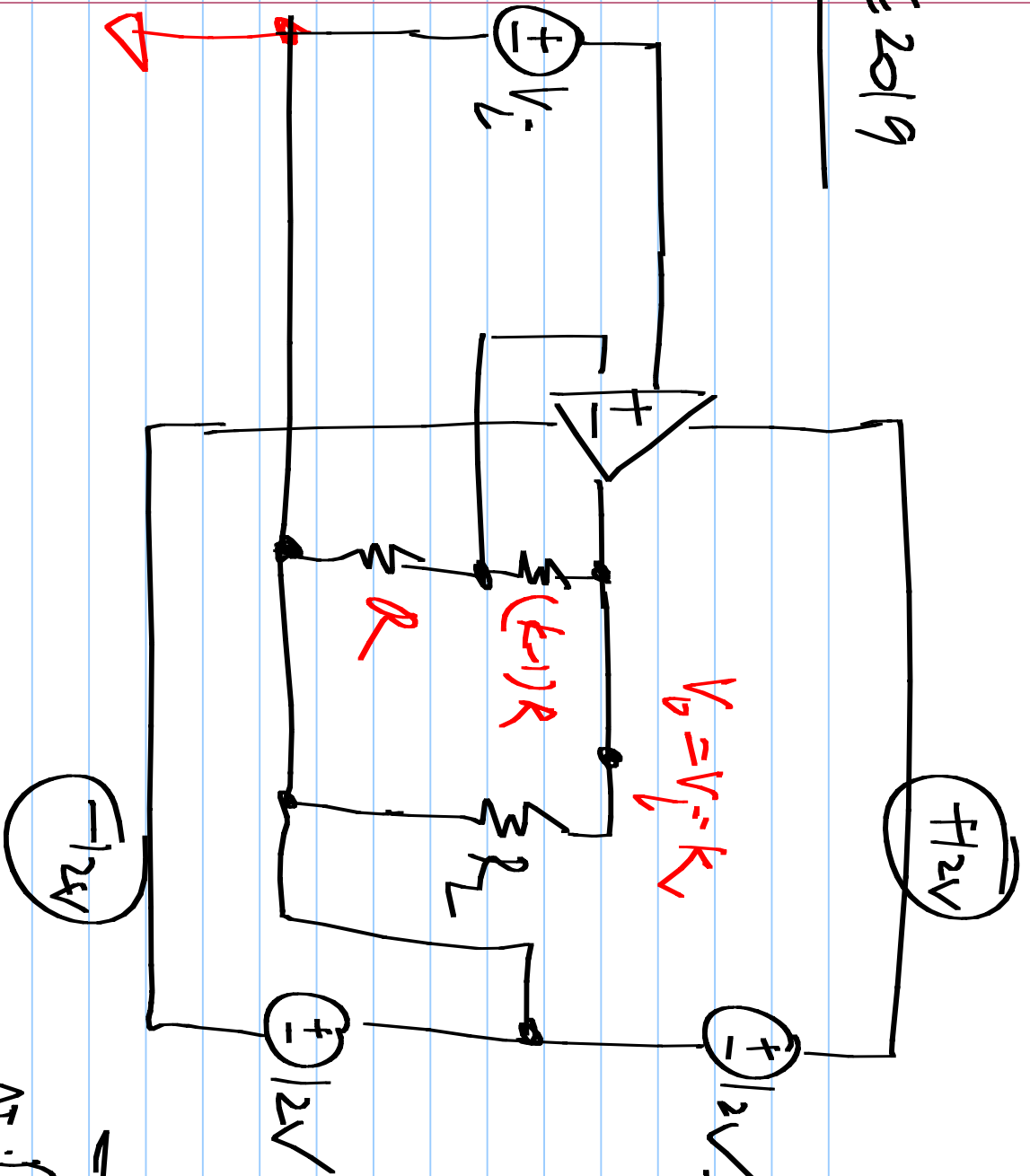

27/1/2017

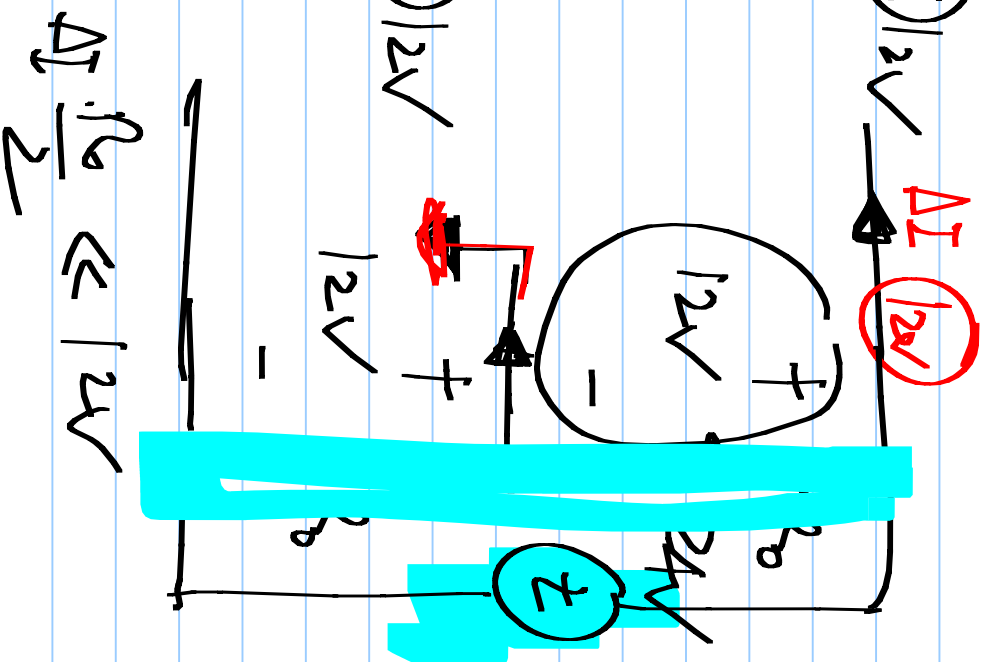

$$\Delta I \cdot R_0 \ll 12V$$

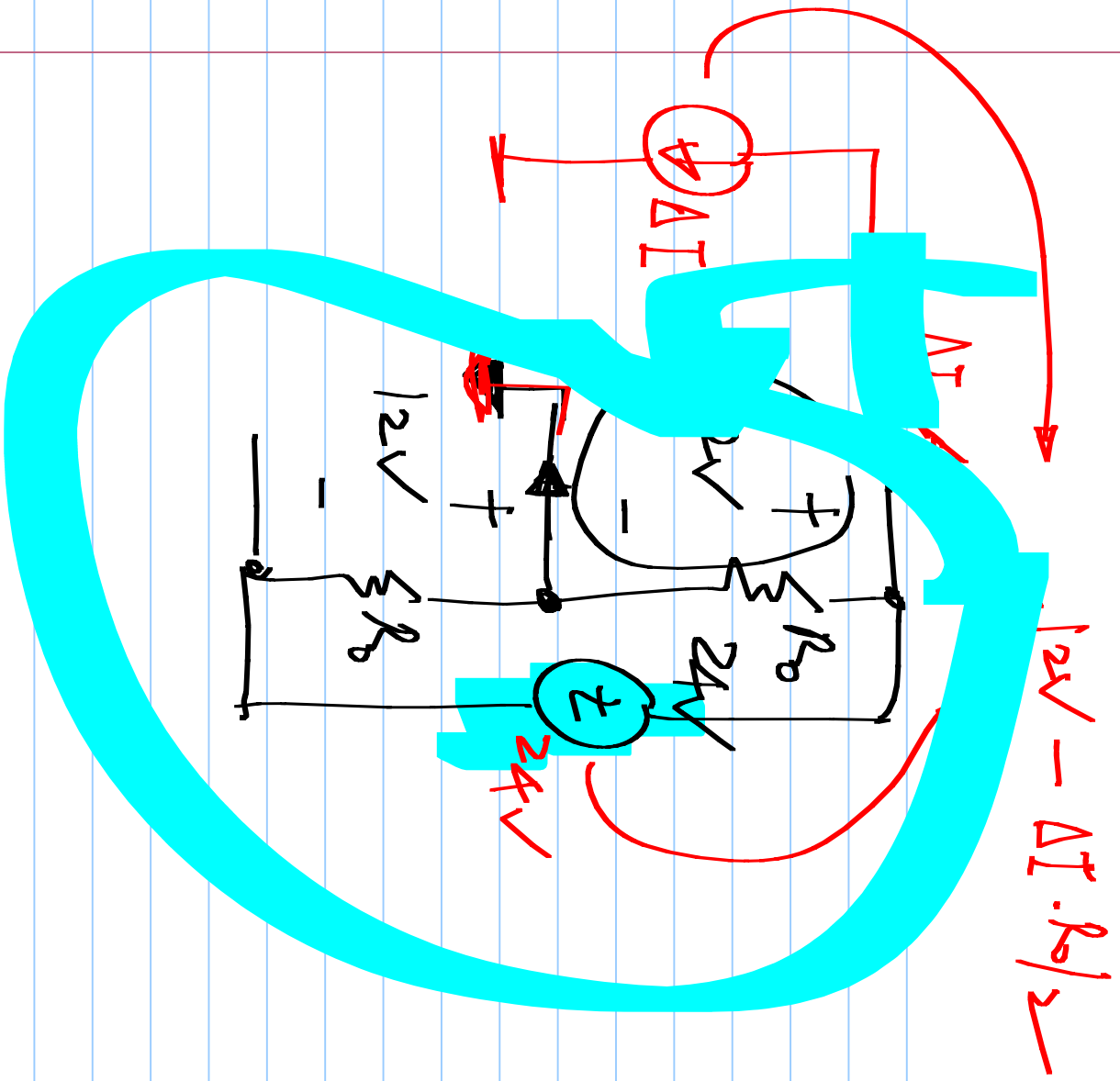

$$12V - \Delta I \cdot R_0 / 2$$

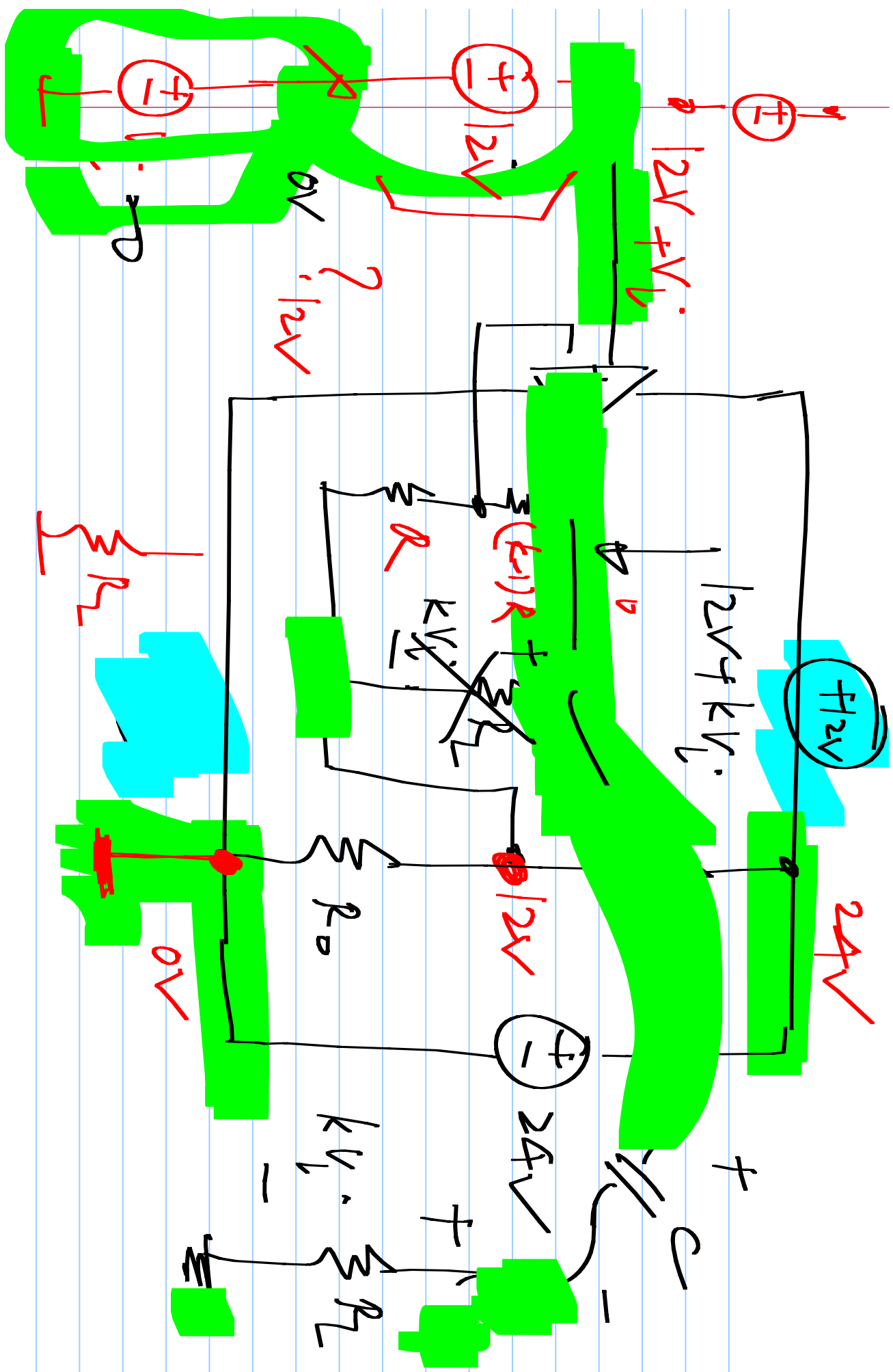

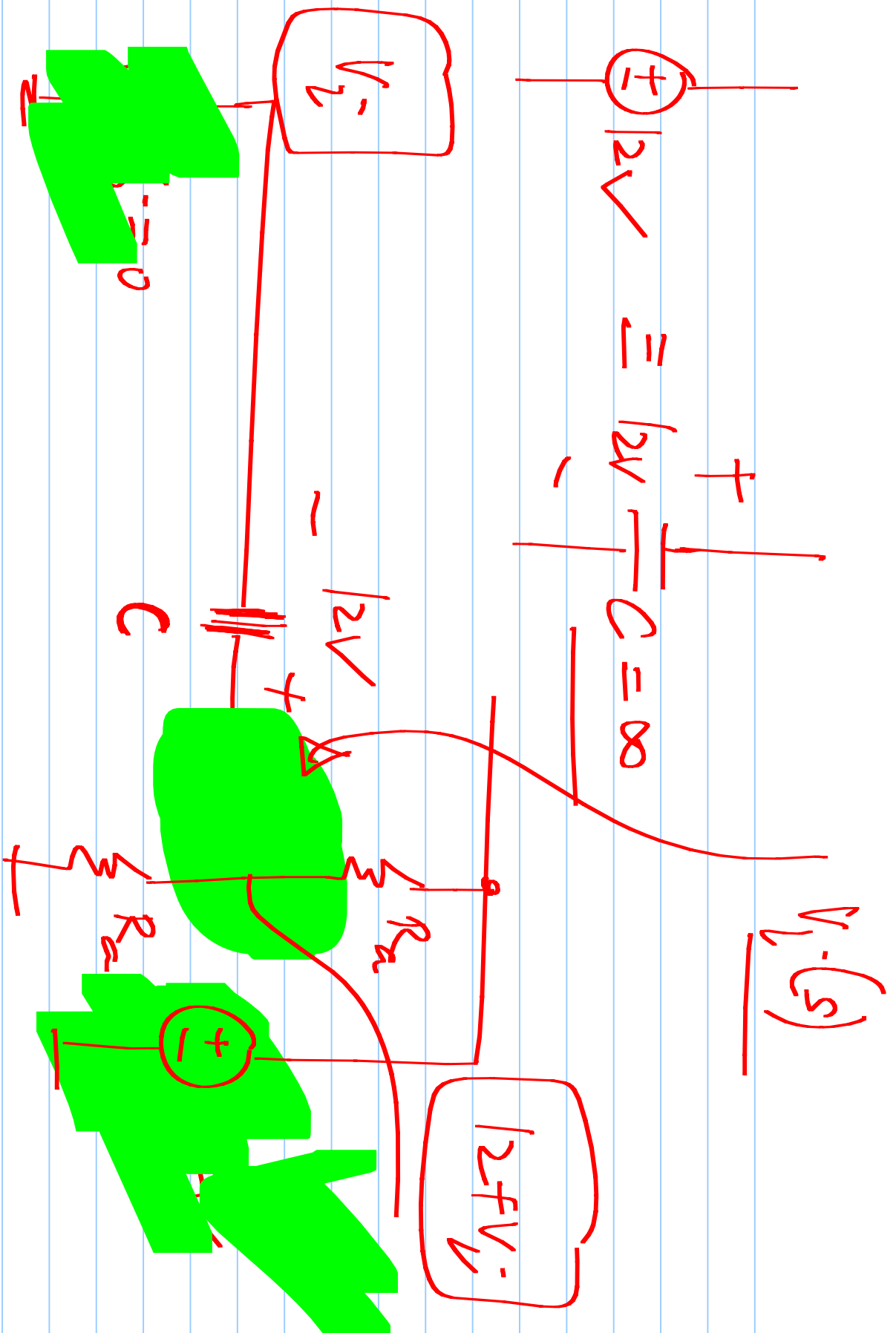

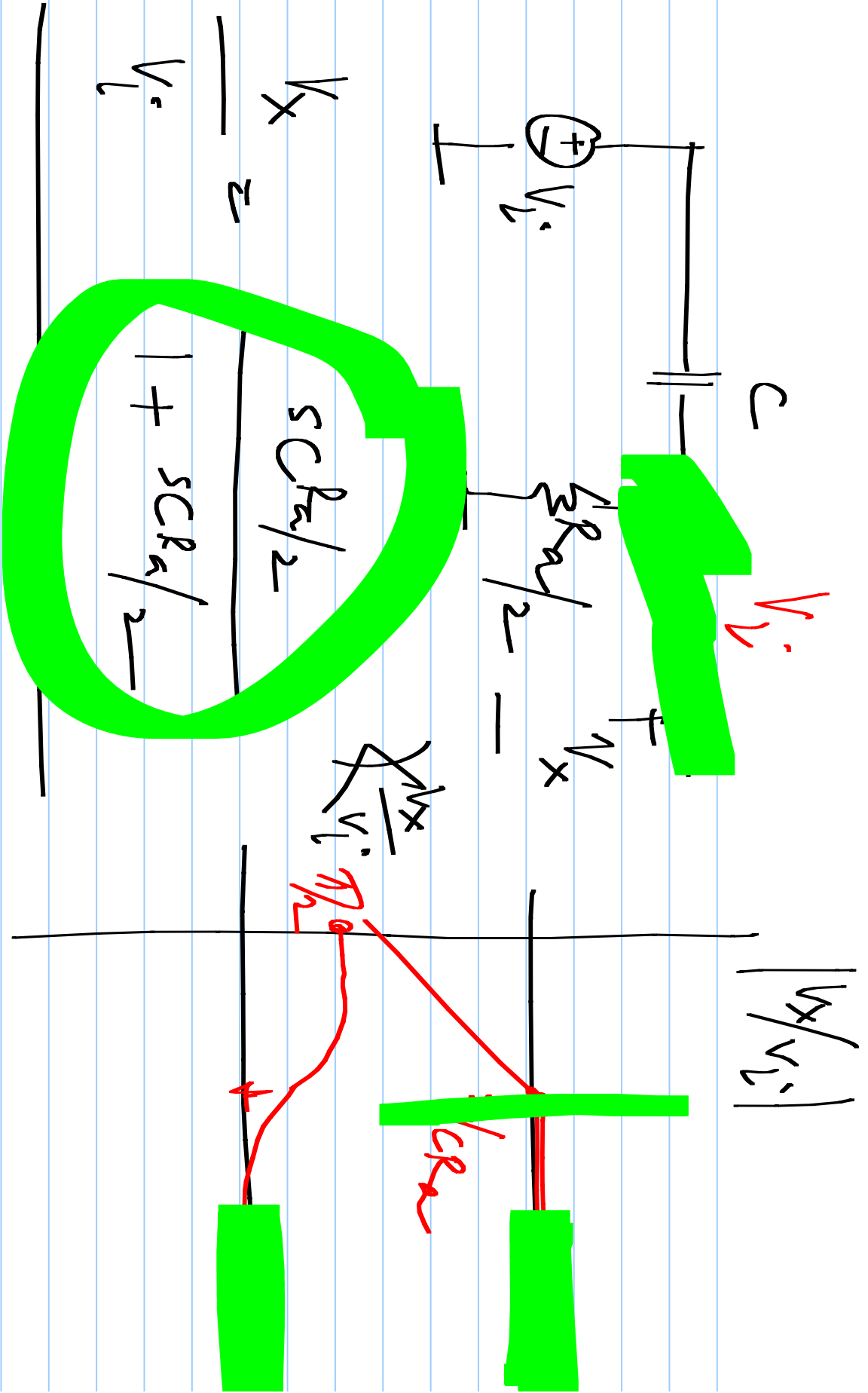

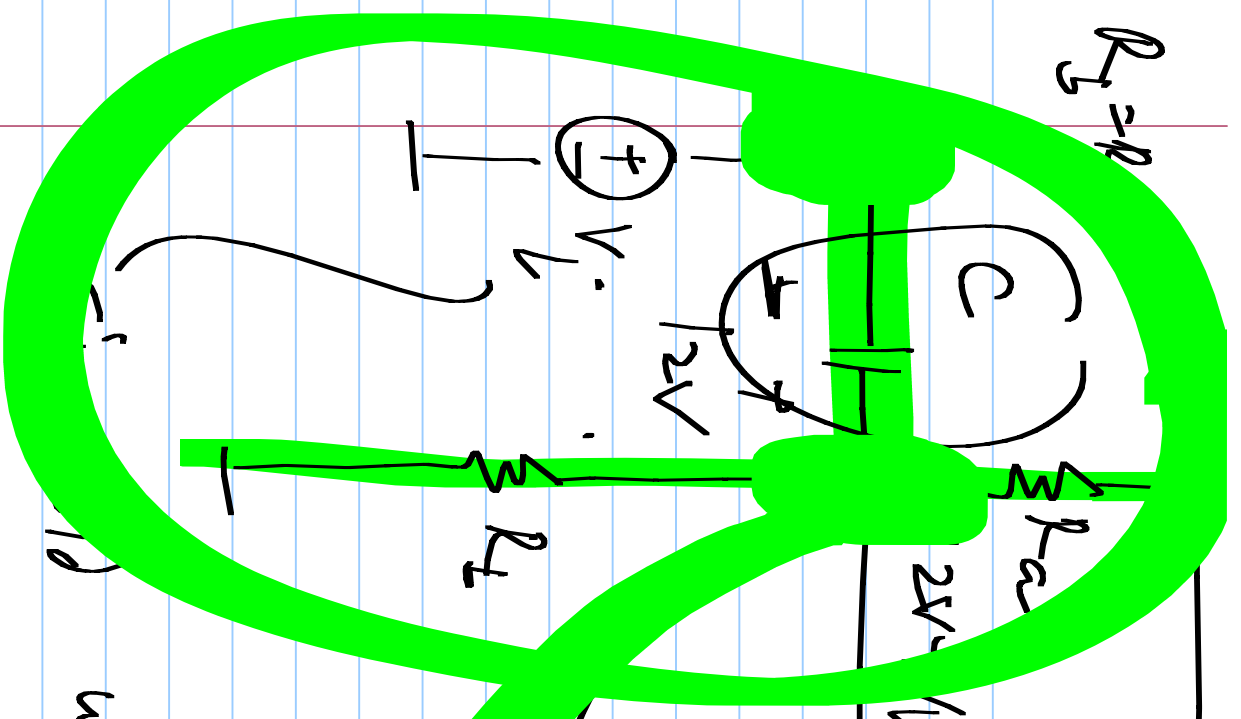

$\omega \gg \frac{2}{R_a C}$

AC-coupling  
 circuit

