

EECE 1010: Electrical and Magnetic Circuits.

Problem set # 6 (Due on 8 Apr. 2013)

HKD: Hayt, Kemmerly, and Durbin

Engineering circuit analysis, 7th Edition

Tata McGraw Hill 2010, 2006

Problem 1:

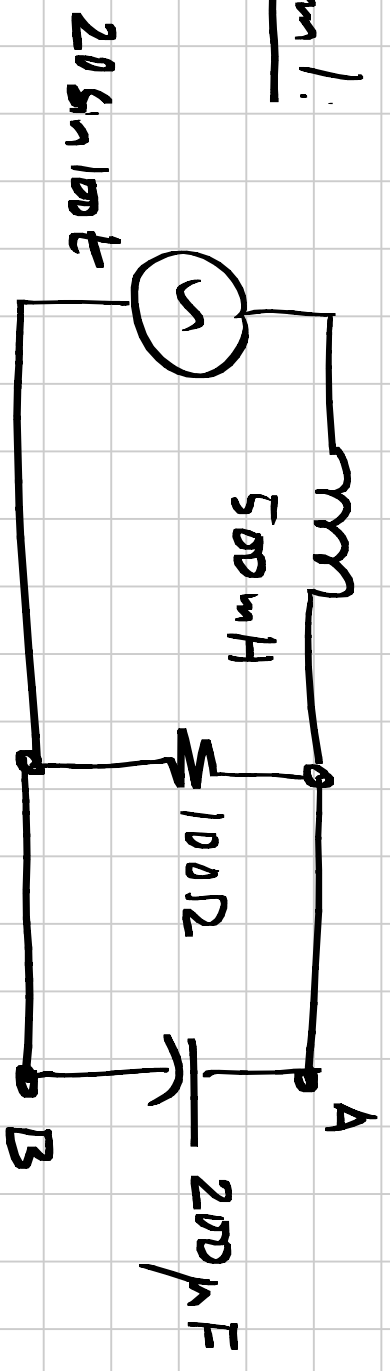
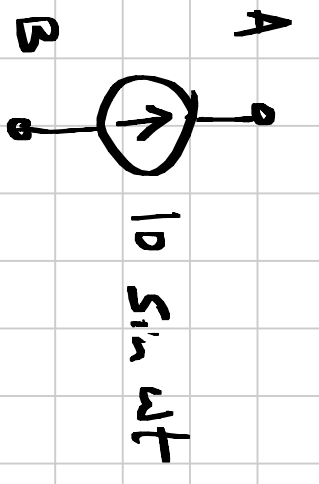

Fig. 1

Determine all branch voltages and currents in steady state, and a phasor diagram representing these voltages and currents.

Problem 2:



Repeat problem 1 when the current source shown is connected to terminals A & B in Fig. 1.

Problem 3: Determine the y-parameters of the following network.

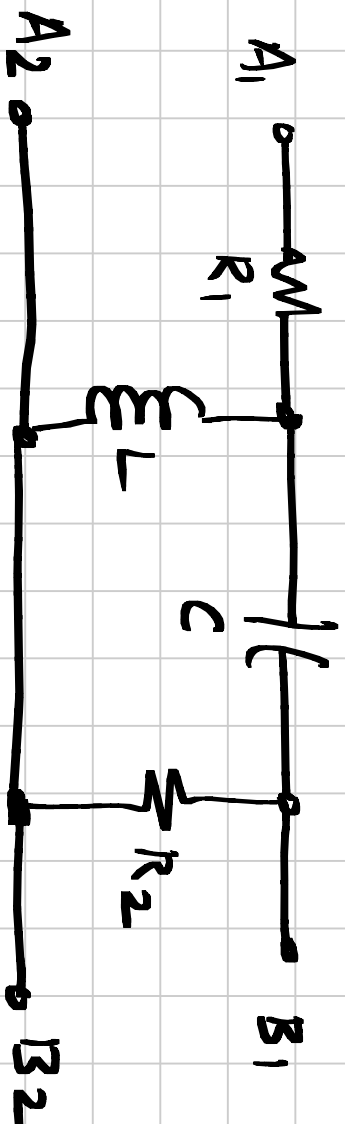

Problem 4:

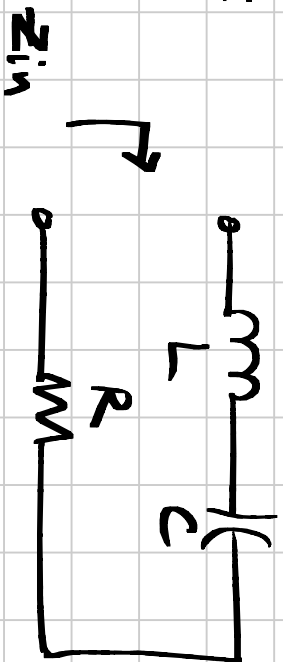

The series RLC network is excited by a voltage at the resonant frequency.

- Determine
- The energy stored in the network at any time.
 - The energy dissipated in the resistor every cycle
 - What is the ratio of the two energies above?

Problem 5: Represent the following in phasor notation

(a) $2 \sin(30t)$ (b) $2 \sin(30t + 2)$ (c) $-2 \sin(30t - 5\pi/6)$

(d) $-2 \cos(-30t + 5\pi/6)$ (e) $-2 \sin(30t - \frac{5\pi}{2}) + 2 \cos(30t - \frac{5\pi}{2})$

(f) $2 \sin(-30t + 5\pi/6) + 2 \sin(30t + 5\pi/6)$

Problem 6:

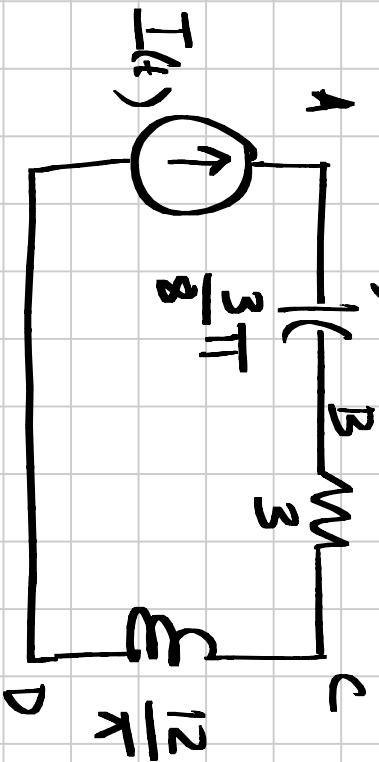

The following observations are made about the sinusoidal current source in the figure.

- (a) At time t_1 , $I = 10A$ and $\frac{dI}{dt}$ is negative.
- (b) At time $t_1 + 2$, $I = 10A$ and $\frac{dI}{dt}$ is positive.

(c) In the time interval $t = t_1$ to $t = t_1 + 2$, $\mathcal{E}(t)$ has never been more than 10 A.

(d) The energy stored in the inductance has a maximum value of $2400 \mu\text{J}$.

Determine the steady state voltage waveforms across the inductor, resistor and capacitor. What is the energy dissipated in the resistor over one cycle?

Problem 7:

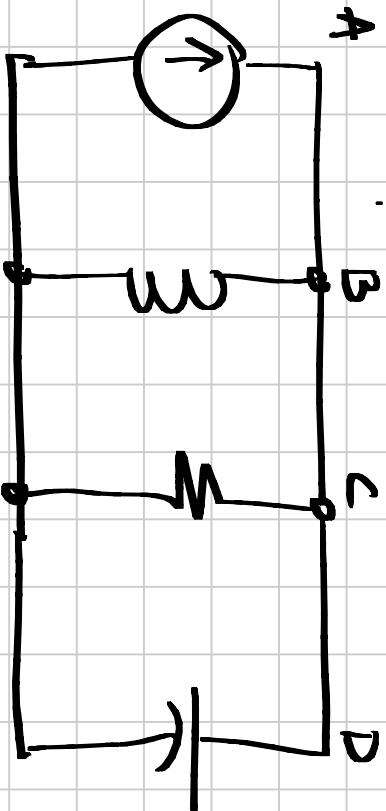

In the network shown in the figure, the currents in the sections AB, BC and CD have

maximum values of 5, 5 and 4A respectively, and the maximum voltage across the parallel combination is 120V. Determine the values of the impedances of the three branches of the network and the phase angle between I_{AB} & I_{CB} .

Problem 8:

(a) When the element X across AB is a 2.5 μ F capacitance, the voltage

$$V_{AB} = E_1, \text{ where } |E_1| = 100V$$

(b) When X is a 2H inductor, $V_{AB} = E_2$, where $|E_2| = 40V$
 E_2 leads E_1 by 90° .

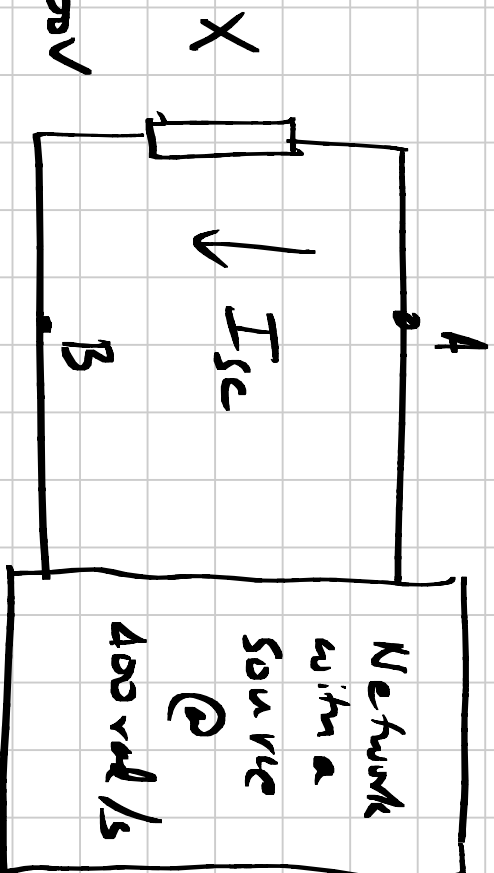

(c) Determine I_{sc} , the short circuit current flowing from A to B if X is replaced by a short, and its phase angle w.r.t E_1 .

Problem 9:

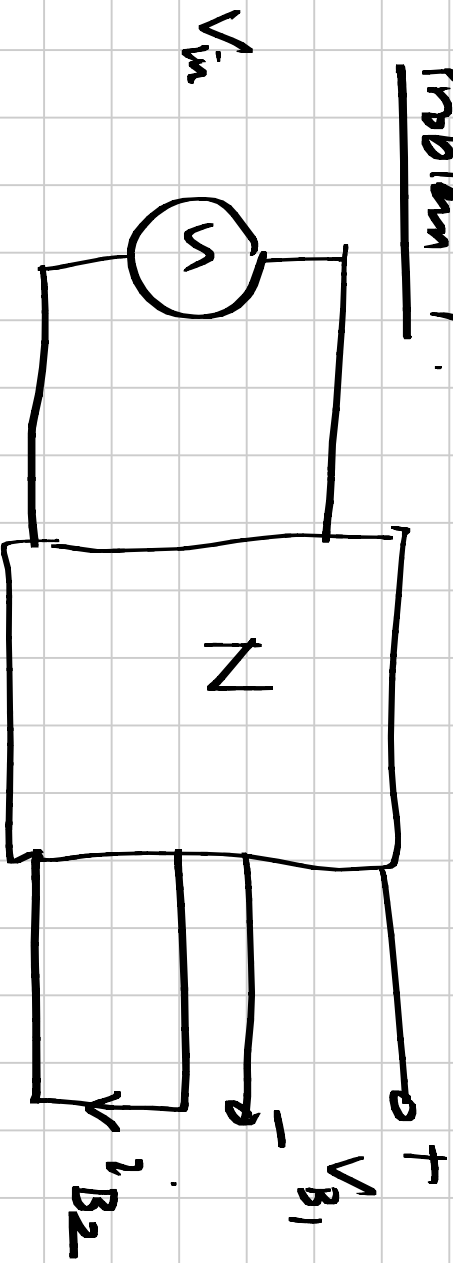

The network N consists of R, L & C and operates in steady state at freq. ω_1 .

A particular branch voltage V_B1 & branch current i_B2 are denoted in phasor notation by V_A & I_B .

(a) Now all resistors and inductors in the network are multiplied by

The number k , while all capacitors are divided by k . Determine V_B & i_{B2} in phasor notation.

(b) In the original network, all inductors and capacitors are decreased by " k " (Resistors are not changed) and input frequency is increased by k . Determine V_{B1} & i_{B2} now.

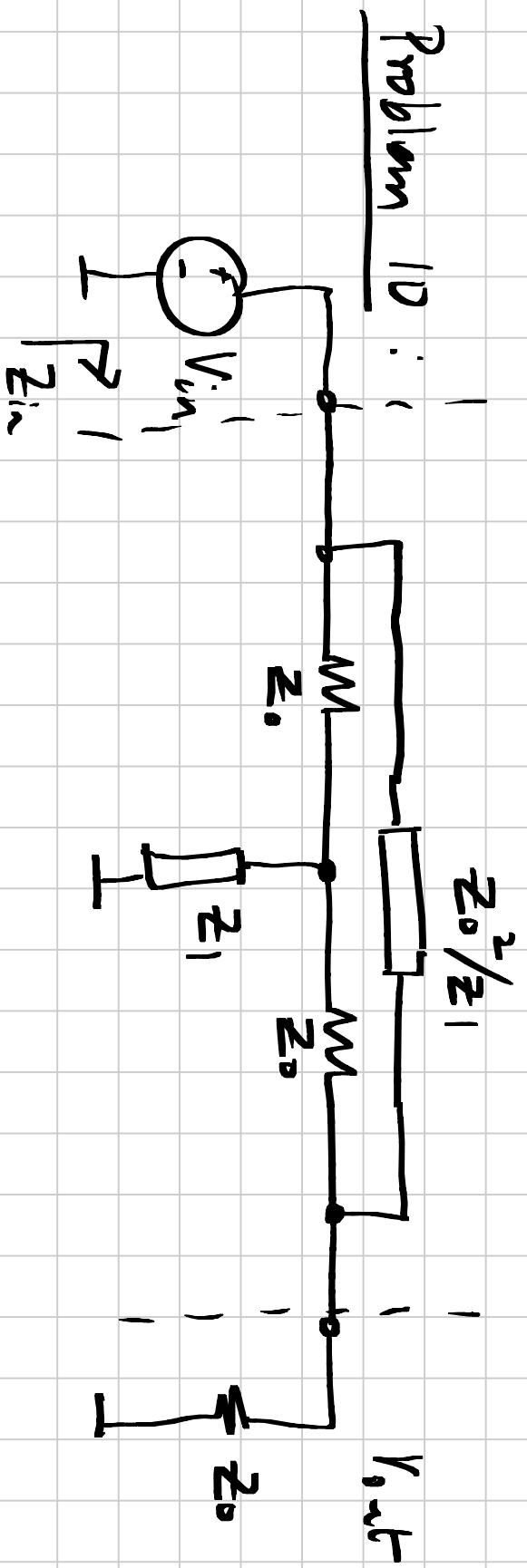

Determine the looking-in impedance Z_{in} and

V_{out}/V_{in} . Do the same for the network below.

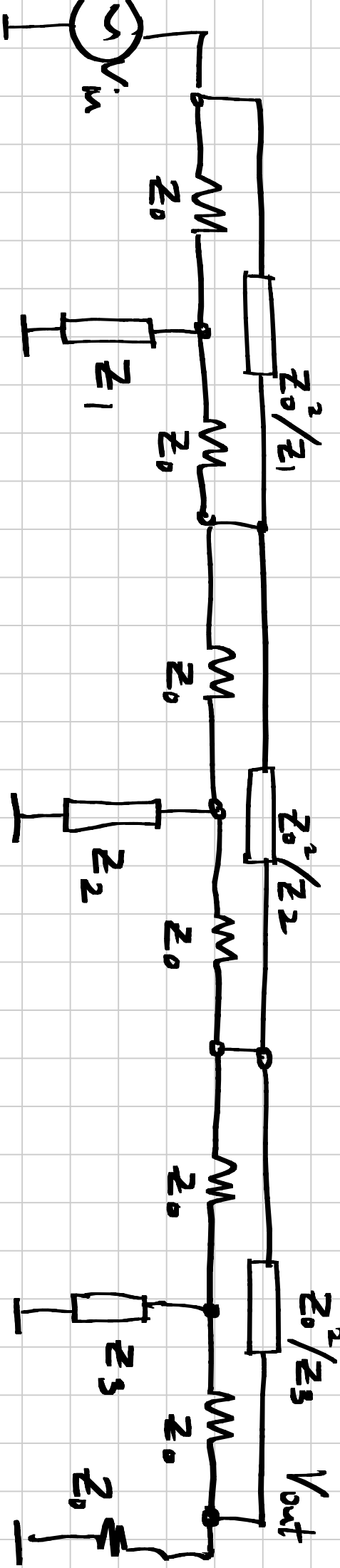

Problem 11:

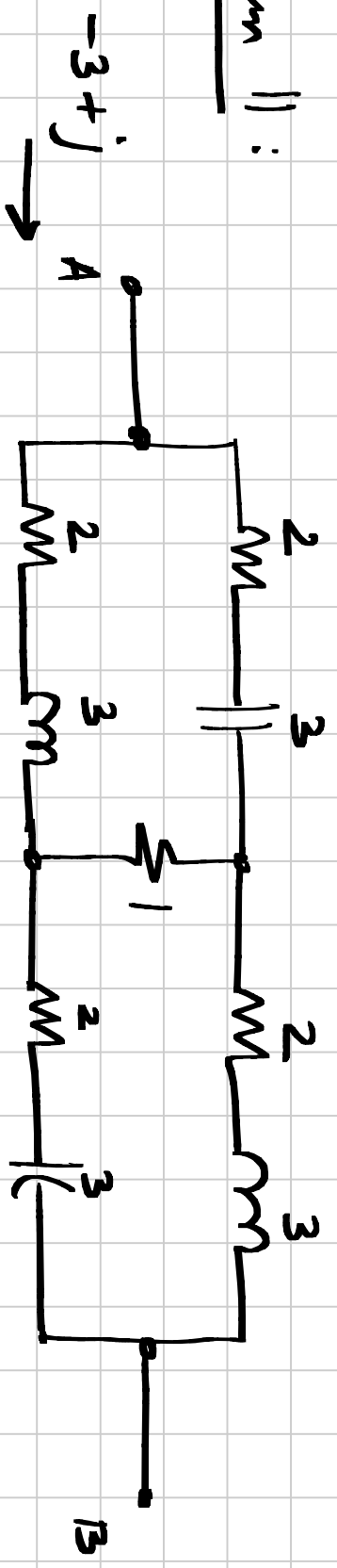

All resistance & reactance values are in ohms.

A current $(-3 + j)$ enters the network at A and leaves at

B. Determine the current through the 1Ω resistor.

(12) Sketch the magnitude and phase of $\left| \frac{V_o}{V_i} \right|$ versus frequency. For the magnitude, use logarithmic x - and y -axes. For phase use a linear y - and a logarithmic x -axis. Clearly show all the regions and mark the slope of the magnitude plot in dB/decade.

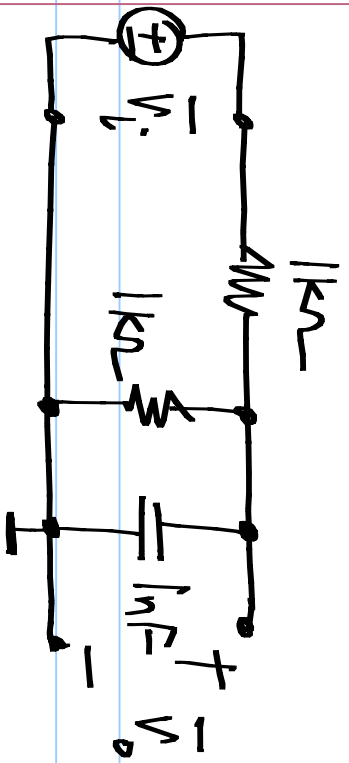

(a)

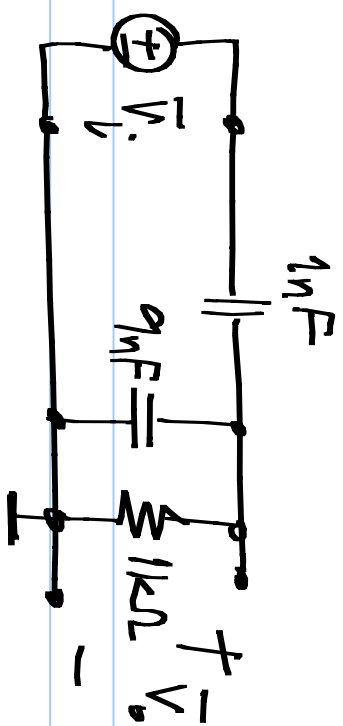

(b)

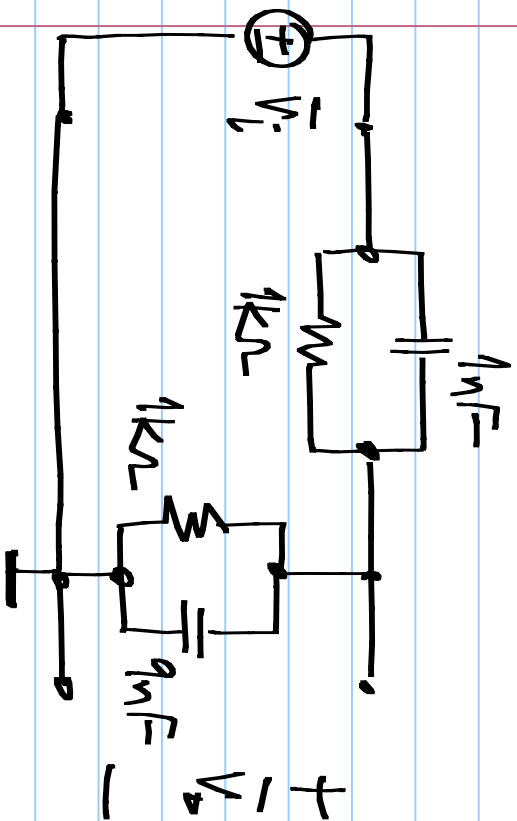

(c)

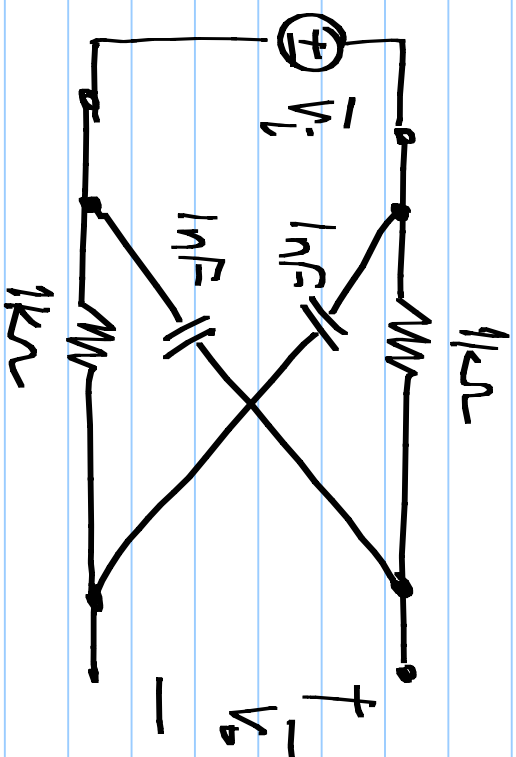

(d)